

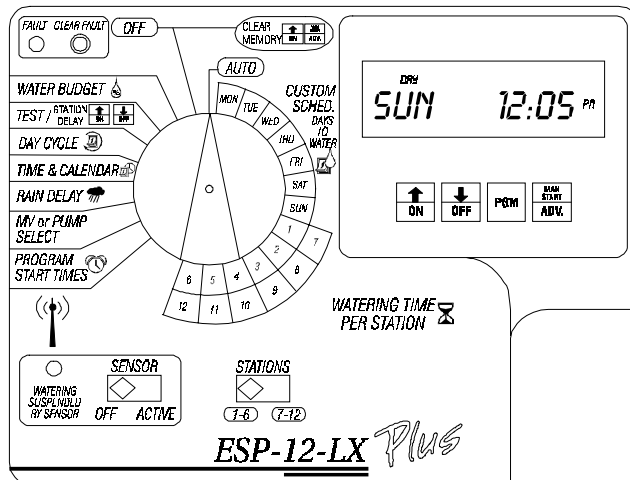

Installation, Programming, & Operation Guide ESP-LX+ and ESP-LXi+



Indoor / Outdoor Models

ESP-6LX+ ESP-16LX+
ESP-8LX+ ESP-20LX+
ESP-12LX+ ESP-24LX+

Indoor Models

ESP-8LXi+
ESP-12LXi+
ESP-16LXi+

Rain Bird Sales, Inc. - Turf Products

970 W. Sierra Madre, Azusa, CA 91702

www.rainbird.com

P/N 634415-B

Special Upgrade Offer

Save an extra 15% off new sprinkler timers and irrigation controllers at the Rain Bird Online Store.*

Still struggling with your old sprinkler timer? Having a hard time complying with local watering restrictions? Upgrading to a new Rain Bird sprinkler timer is easier than you might think.

New timers are easier to program than ever before, with powerful features to help save you time and water while keeping your yard healthy and vibrant.

There are lots of models to meet your needs, including indoor and outdoor versions, flexible modular timers and even smart controllers that automatically adjust themselves based on the weather.

Shop Now at store.rainbird.com and enjoy exclusive upgrade savings!



Enter discount code:

UPGRADE15

at checkout to save an extra 15% off*

** Additional discount not valid on clearance items, bundles or store specials. Discount applies to controller products only. Cannot be combined with other store discount codes. Valid at the Rain Bird Online Store only. Subject to change without notice.*

RAIN  BIRD®

TABLE OF CONTENTS

Introduction	2	Run Program(s) Manually	34
LX+ and LXi+ Series Controllers	2	Run Station(s) Manually	35
Controller Stations	2	Run Test Program	36
Station Layout	3	Rapid Station Test Routine — RASTER™	37
Controls, Switches, and Indicators	4	Introduction	37
Programming the Controller	6	RASTER Operation	38
Definitions	6	Running a RASTER (Rapid Station Test Routine)	38
Programming Under Battery Power	6	Valve Testing	40
Programming Checklist	7	Troubleshooting Open and Shorted Valve Circuits	43
Fill Out Programming Chart	8	Open Circuits	43
Clear All Program Information	10	Short Circuits	44
Set Time	11	Installing the Controller	45
Set Date	12	Installation Checklist	45
Select Program	13	Select Location	46
Set Watering Day Cycle	14	Remove Door and Face Panel	48
Custom	14	Mount Controller on Wall	50
Cyclical	16	Connect Field Wires	52
Odd/Even Cycle	18	Field Wire Entrances	52
Set Station Watering Times	19	Station Valve Wiring	53
Set Program Start Times	21	Master Valve Wiring	53
Set Water Budget	23	Sensor System Wiring	54
Set Station Delays	24	Pump Start Relay Wiring	55
Set MV / Pump Starts	26	Connect Main Power Wires	56
Set Rain Delay	28	ESP-LX+ (Outdoor / Indoor Controller)	56
Set Calendar Days OFF	29	ESP-LXi+ (Indoor only Controller)	60
Set Sensor System and Bypass Switch	31	Install Battery	62
Operating the Controller	33	Diagnostic Circuit Breaker	64
Operate Controller Automatically	33	Troubleshooting	65

WARNING: A CIRCUIT BREAKER OR CUTOFF SWITCH IS TO BE PROVIDED IN THE FIXED WIRING TO ISOLATE THE CONTROLLER.

MEMORY IS RETAINED BY A BATTERY, WHICH IS TO BE DISPOSED OF IN ACCORDANCE WITH LOCAL REGULATIONS.

CAUTION ICONS



The lightning flash with arrowhead symbol, within an equilateral triangle, is intended to alert the user to the presence of uninsulated “dangerous voltage” within the product’s enclosure that may be of sufficient magnitude to constitute a risk of electronic shock to persons.

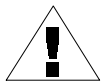

The exclamation point within an equilateral triangle is intended to alert the user to the presence of important operating and maintenance (servicing) instructions in the literature accompanying the product.

ATTENTION: UN DISJONCTEUR OU UN INTERRUPTEUR DOIT ETRE INSTALLE SUR LE PRIMAIRE POUR ISOLER LE PROGRAMMATEUR.

LA MEMOIRE EST MAINTENUE GRACE A UNE BATTERIE RECHARGEABLE A DISPOSER SELON LA REGLEMENTATION LOCALE.



L’éclair avec le symbole de la flèche, placé dans les limites d’un triangle équilatéral est prévu pour avertir l’utilisateur de la présence de “tension dangereuse” non isolé dans l’enceinte du produit qui pourrait être d’une importance suffisante pour présenter un risque d’électrocution aux personnes.

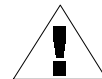

Le point d’exclamation dans un triangle équilatéral est prévu pour avertir l’utilisateur de la présence d’instructions importantes pour les opérations et l’entretien (service) dans les manuels fournis avec l’appareil.

INTRODUCTION

LX+ and LXi+ Series Controllers

The ESP (*Extra Simple Programming*) -LX+, -LXi+ Series controller is an irrigation timing system for residential and light commercial use.

The ESP-LX+ comes in 6-, 8-, 12-, 16-, 20-, or 24-station models, designed for either indoor or outdoor use. The ESP-LXi+ comes in 8-, 12-, or 16-station models, for indoor use only.

ESP-LX+ and ESP-LXi+ controllers bearing the “remote ready” icon (shown at right) can be connected to Rain Bird’s Radio Frequency (RF) receivers (RM-1R & RMX-1R).



Controller Stations

Your ESP-LX+ or LXi+ Series controller is an electronic clock that controls when your sprinkler system turns on, and how long the sprinklers run. The controller has several sprinkler stations connected to it, as shown in the illustration on the following page. Each station is connected to a remote control sprinkler valve.

The valve opens when it receives power from the controller, and the sprinklers connected to that valve turn on. When these sprinklers have run for their programmed time, the controller shuts off the valve and opens the next valve in sequence.

For example, the illustration on page 3 shows that station 1 is currently watering. When station 1 is finished, the controller will shut it off and start station 2. In the same way, station 3 will begin watering when station 2 is finished.



NOTE: ESP-LX+ and -LXi+ controllers let you set a delay between stations. For example, if you set a one-minute delay, station 1 will run until finished, followed by a one-minute delay. Then station 2 will operate, followed by a one-minute delay.

Station Layout

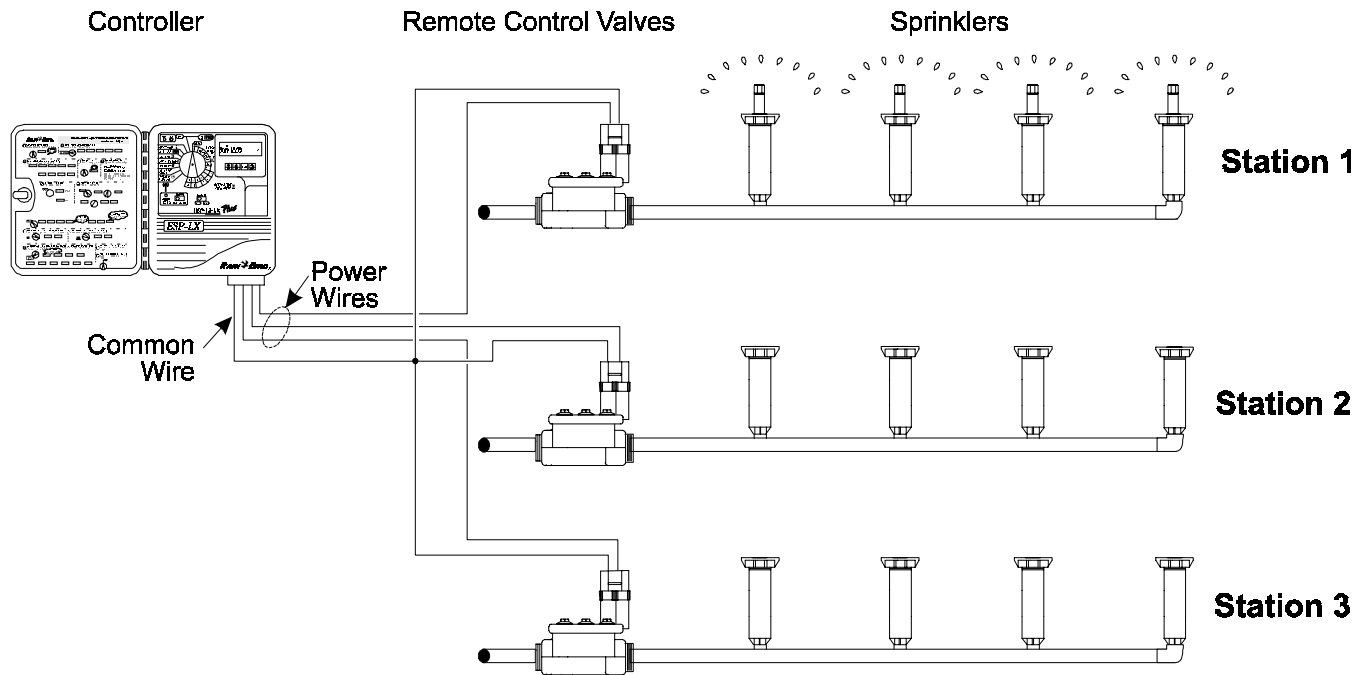

Controls, Switches, and Indicators

This illustration shows the controls, switches, and indicators on ESP-LX+ and LXi+ controllers, including:

- ❶ **Fault LED** — flashes when the controller senses a station short circuit.
- ❷ **Clear Fault Button** — used to turn off the Fault LED and clear the flashing LCD Error indicator after the fault has been corrected.
- ❸ **LCD Display** — during normal operation, displays the time of day; during programming, shows the result of your commands; during watering, shows the station that is running and the minutes remaining in its run time (when program dial is set to the AUTO position).
- ❹ **Manual Start / Advance Button** — used to start a program manually or to manually advance watering from one station to the next. Also used to make program changes.
- ❺ **PGM Button** — used to select watering program A, B, C, or D-drip.
- ❻ **Arrow / ON-OFF Buttons** — used to set times and days, and to make program changes.
- ❼ **Programming Dial** — used to turn the controller off and on, and for programming.

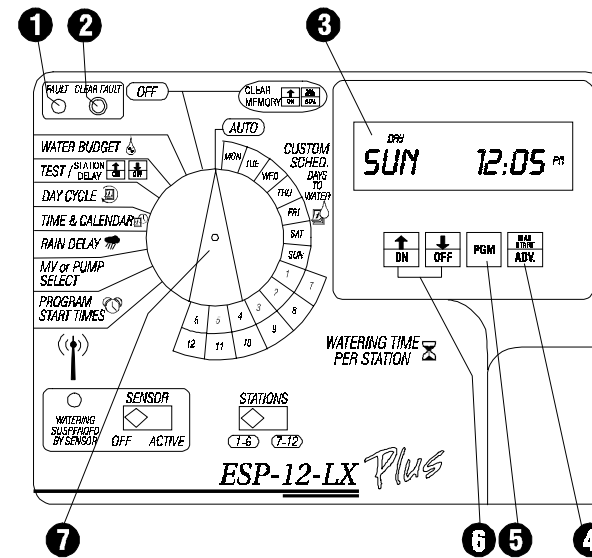

ESP-LX+ & LXi+ Installation, Programming, & Operation Guide

- ⑧ **Watering Suspended by Sensor LED** — glows when watering is prevented by a moisture sensor.
- ⑨ **Sensor Bypass Switch** — used to tell the controller to obey or ignore input from a moisture sensor system. (Sensor systems are optional.)
- ⑩ **Stations Slide Switch** — used to select one of the station rows around the Programming Dial. (For 12-, 16-, 20-, and 24-station models only.)

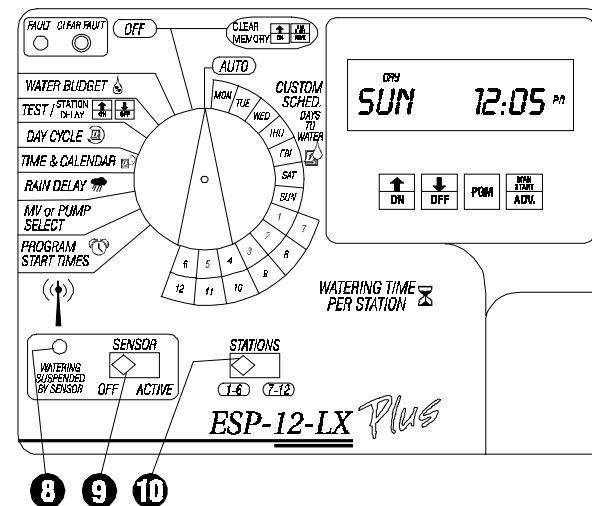



PROGRAMMING THE CONTROLLER

Definitions

Programming is the process of telling the controller exactly when and how long you want to water. The controller opens and closes the remote control valves according to the program you set.

Each program contains:

- **Watering days**  - the specific days of the week on which watering takes place (for example, Monday, Wednesday, Friday), or the watering interval (for example, every third day, or only on even or odd days of the month).

- **Start time(s)**  - the time(s) of day that the program begins; this is the time that the first station in the program begins watering; all other stations in the program then follow in sequence.



NOTE: The term “start time” refers to the time that a **program** starts — **not** to the time that each individual station begins to run.

- **Run time**  - the number of minutes (or hours and minutes) that each station runs.

Programming Under Battery Power

If you wish, you can remove the front face panel of the controller and program the unit under battery power. This feature can be useful if the controller is installed in an area that is not readily accessible. This feature also lets you enter program information before installing the controller at the job site.

To program the ESP-LX+ or ESP-LXi+ controller under battery power, install the battery as described on page 62. To remove the face panel, see the instructions on page 48. The controller can be programmed under battery power, but should not be operated on battery power alone. Connect the controller to an AC power source as soon as possible to avoid battery drain.

Programming Checklist

To program the ESP-LX+ or LXi+ controller for the first time, we recommend that you complete the following steps in order. For your convenience, a check-off box () is provided for each step.

-
- | | |
|--|---|
| <input type="checkbox"/> Fill out Programming Chart Page 8 | <input type="checkbox"/> Set master valve / pump starts for each station (optional).. Page 26 |
| <input type="checkbox"/> Clear all program information Page 10 | <input type="checkbox"/> Set rain delay (optional). Page 28 |
| <input type="checkbox"/> Set time and date. Page 11 | <input type="checkbox"/> Set calendar day(s) OFF (optional). Page 29 |
| For each program: | <input type="checkbox"/> Set sensor system and bypass switch (optional). Page 31 |
| A B C D | <input type="checkbox"/> Set controller to automatic operation. Page 33 |
| <input type="checkbox"/> <input type="checkbox"/> <input type="checkbox"/> <input type="checkbox"/> Select program (A, B, C, or D-drip). ... Page 13 | <input type="checkbox"/> Run test program (optional). Page 36 |
| <input type="checkbox"/> <input type="checkbox"/> <input type="checkbox"/> <input type="checkbox"/> Set watering day cycle Page 14 | |
| <input type="checkbox"/> <input type="checkbox"/> <input type="checkbox"/> <input type="checkbox"/> Set station watering times. Page 19 | |
| <input type="checkbox"/> <input type="checkbox"/> <input type="checkbox"/> <input type="checkbox"/> Set program start time(s). Page 21 | |
| <input type="checkbox"/> <input type="checkbox"/> <input type="checkbox"/> <input type="checkbox"/> Set water budget (optional). Page 23 | |
| <input type="checkbox"/> <input type="checkbox"/> <input type="checkbox"/> <input type="checkbox"/> Set station delays (optional). Page 24 | |

Fill Out Programming Chart

Before you begin programming, fill out the Programming Chart and attach it to the inside of the controller door. A sample Programming Chart is shown on page 9. Follow these instructions to complete the chart.

- 1 Describe the sprinklers or plant zones covered by each station on the controller.
- 2 Indicate which stations drive a master valve or booster pump relay by checking "ON" in the MV / Pump column. (See page 26 for more information).
- 3 In the Program "A" column, for Custom cycle, circle the specific days of the week; for Cyclical schedule, write the cycle period (e.g., "3-day cycle" means every third day); for ODD/EVEN-day watering, check ODD or EVEN.
- 4 Enter the start time for Program A. You may enter up to six start times for each program, but only one is needed to run the program.

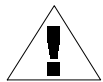

NOTE: Start times apply to the program, *not* to the individual stations assigned to the program. In this example, Program A begins watering at 8:00 a.m. on Mondays, Tuesdays, Thursdays, and Saturdays. Station 1 runs for ten minutes, followed by Station 2 for 20 minutes, Station 3 for 20 minutes, and Station 4

for 5 minutes. The entire program takes about an hour.

- 5 Enter the watering run time (in hours and minutes) for each station assigned to Program A.
- 6 Enter the water budget percentage by program. The water budget for sample Program A is set to 80%.
- 7 Enter the station delays for Program A. A station delay is the time between the end of one station's operation and the beginning of the next. Use a station delay to let a water well recover or to allow slow-closing valves to turn off completely. If neither of these situations applies to your site, leave the station delay set to 0. A station delay setting applies to all stations in the program.
- 8 Make any special notes in the space provided.
- 9 Repeat steps 2 through 7 for Programs B, C, and D.



NOTE: Stations assigned to Program D cannot be used in any other programs. See page 19 for more information.

In the sample chart, Program A has a one-minute delay between stations. When Station 1 ends, the controller waits one minute before starting Station 2. There will also be a one-minute delay between Station 2 and Station 3, etc.

Clear All Program Information

To ensure you begin with a “clean” setup, clear the controller of all existing program settings.

- 1 Turn the dial to “OFF.”
- 2 Hold down “ON” and “MAN. START/ADV.” for about seven seconds until the display reads INITSYS and then begins to scroll.
- 3 When the last digit in “SUN 12:00” flashes in the display, the existing program settings have been cleared.

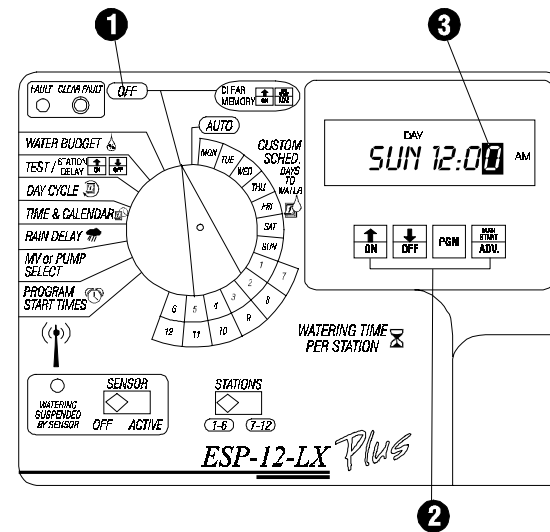

Set Time

Before you can program the controller, you must set its internal clock to the correct time and date.

- 1 Turn the dial to “TIME & CALENDAR.”
- 2 The hour digits in the display flash.
- 3 Press \uparrow or \downarrow to set the current hour. Make sure the AM/PM indicator is set to the correct designation.
- 4 Press “MAN. START/ADV.”
- 5 The minutes digits in the display flash.
- 6 Press \uparrow or \downarrow to set the current minute.

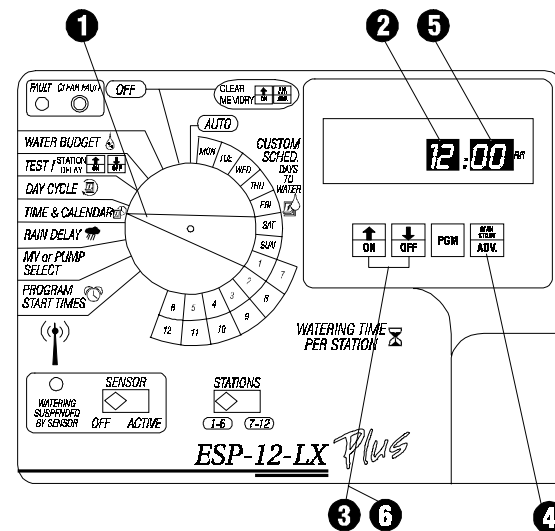

Set Date

- ❶ Press “MAN. START/ADV.” until the date (1/JAN/95) shows in the display.
- ❷ The month flashes in the display.
- ❸ Press \uparrow or \downarrow to set the current month.
- ❹ Press “MAN. START/ADV.”
- ❺ The day number flashes in the display.
- ❻ Press \uparrow or \downarrow to set the current day of the month.
- ❼ Press “MAN. START/ADV.”
- ❽ The year flashes in the display.
- ❾ Press \uparrow or \downarrow to set the current year.
- ❿ You are finished setting the time and date. Turn the dial to “AUTO.”

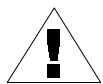

NOTE: If you do not want to water on a specific day of the month or on the 31st of any month, see “Set Calendar Days Off” on page 29.

12

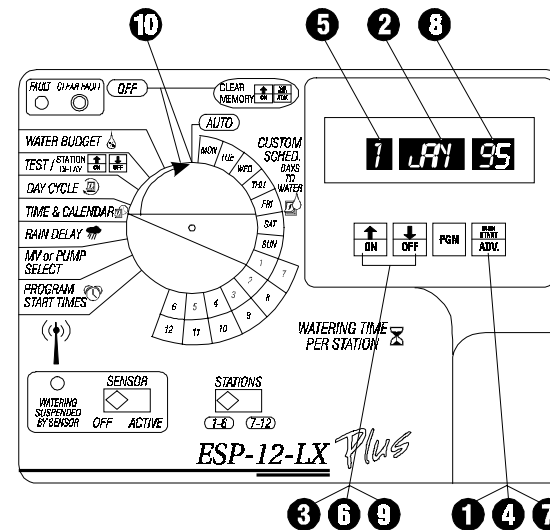

ESP-LX+ & LXi+ Installation, Programming, & Operation Guide

Select Program

Four independent programs are available in the ESP-LX+, LXi+ Series controller: A, B, C, and D-drip. Multiple independent programs let you enter watering schedules to meet the requirements of different types of plant materials, soils, slopes, shady or sunny areas, etc.

The D-drip program is designed for drip irrigation equipment. Stations assigned to the D-drip program cannot be assigned to any other program. The D-drip program can overlap, or run concurrently, with programs A, B, or C.

Programs A, B, and C are not allowed to overlap each other. If they are programmed to overlap, programs A, B, or C will “stack” (run in consecutive order upon the completion of the program in progress).

Program “stacking” prevents excessive flow demand and low water pressure caused by having too many valves running at one time.



NOTE: It is easier to select one program and program it completely. Jumping from program to program can be confusing.

- 1 Turn the dial to “AUTO.”
- 2 Press “PGM” to cycle through the available programs. The program indicator on the far left side of the display shows which program is currently selected.

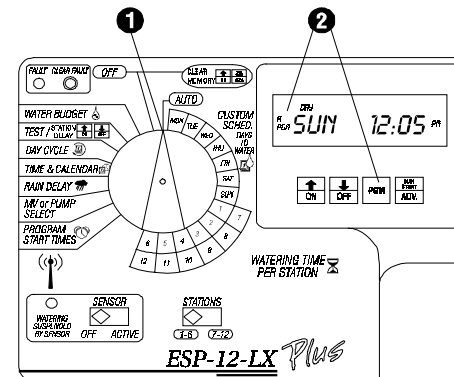

Set Watering Day Cycle

Each program can operate in one of four watering day cycles:

1. CUSTOM waters on the days of the week you select. See the instructions below.
2. CYCLICAL waters on a selected daily interval (for example, every other day, or every third day). See page 16.

3. ODD waters only on odd-numbered days of the month. See page 18.

4. EVEN waters only on even-numbered days of the month. See page 18.

Custom

To set a custom cycle:

- 1 Turn the dial to “DAY CYCLE.”
- 2 The display shows the currently selected program. If the program you want is not displayed, press “PGM” until it appears.
- 3 Press \uparrow or \downarrow until “CUSTOM” appears in the display.

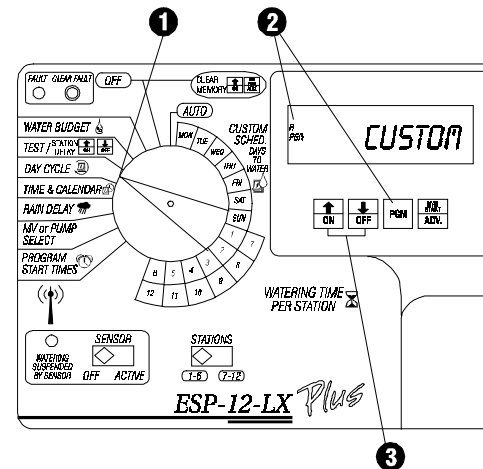

- 4 Turn the dial to "MON."
- 5 The display shows the selected day and either "ON" or "OFF." ON means the selected day is a watering day. OFF means watering doesn't take place on that day.
- 6 Press \uparrow or \downarrow to set the day ON or OFF.
- 7 Turn the dial to the next day of the week. Repeat steps 5 and 6 until you have set each day of the week ON or OFF.
- 8 Turn the dial to "AUTO."

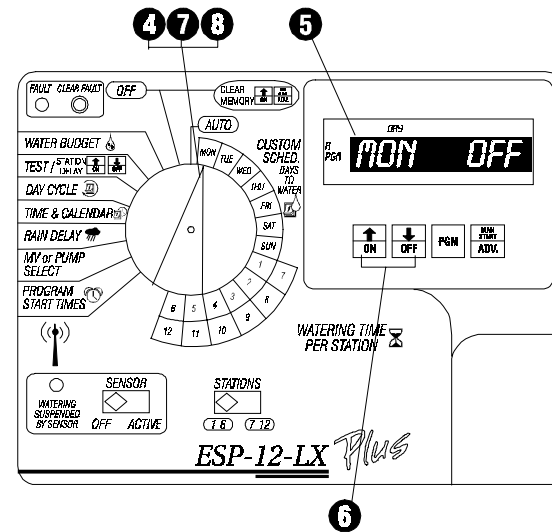

Cyclical

To set a cyclical schedule:

- 1 Turn the dial to “DAY CYCLE.”
- 2 The display shows the currently selected program. If the program you want is not displayed, press “PGM” until it appears.
- 3 Press \uparrow or \downarrow until “CYCLIC” appears in the display.
- 4 Press “MAN. START/ADV.”
- 5 The display shows the number of days remaining until a watering day and the number of days in the cycle. The “DAY CYCLE” digit flashes.
- 6 Press \uparrow or \downarrow to set the number of days in the cycle. For example, if you want to water every other day, set the day cycle to “2.” If you want to water every third day, set the day cycle to “3.”

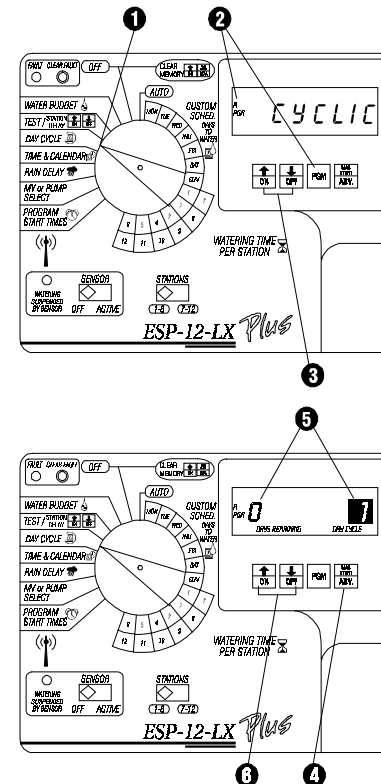

ESP-LX+ & LXi+ Installation, Programming, & Operation Guide

- 7 Press "MAN. START/ADV."
- 8 The DAYS REMAINING digit flashes.
- 9 Press \uparrow or \downarrow to set the number of days remaining before the next watering day. "0" means that today is a watering day. So if you want watering to begin tomorrow, set the days remaining to "1."
- 10 Turn the dial to "AUTO."

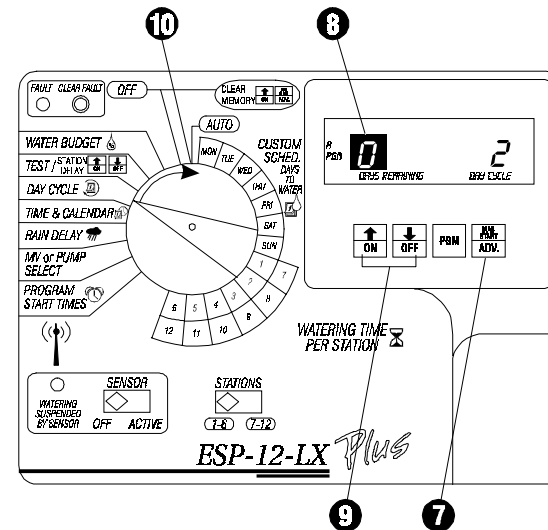

Odd/Even Cycle

To set an odd/even cycle:

- 1 Turn the dial to “DAY CYCLE.”
- 2 The display shows the currently selected program. If the program you want is not displayed, press “PGM” until it appears.
- 3 Press \uparrow or \downarrow until “ODD” or “EVEN” appears in the display.
- 4 Turn the dial to “AUTO.”

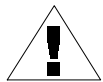

NOTE: If you do not want to water on the 31st of any month (a restriction imposed in some local areas), you must set the 31st day OFF. See page 29 for instructions.

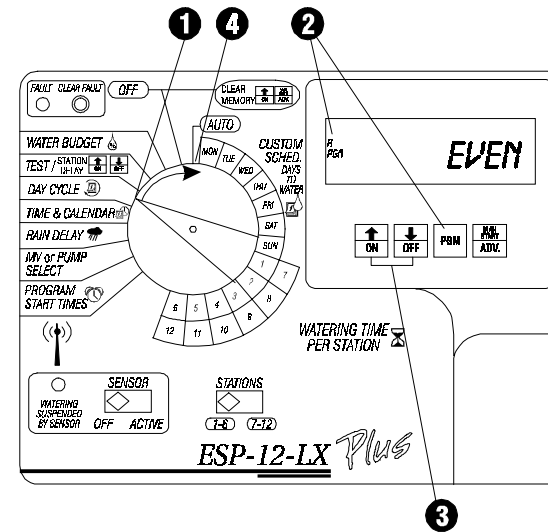

Set Station Watering Times ⌚

You can set any station to run from 0 to 12 hours. For the first two hours, you can set the watering time in one-minute increments. For the remaining 10 hours, you can set the watering time in 10-minute increments.

- 1 On 12-, 16-, 20-, and 24-station models, set the “STATIONS” side switch to the block of stations you want to set.
- 2 Turn the dial to the station number you want in the “WATERING TIME PER STATION” section of the dial.
- 3 The display shows the program, the station number, and the currently set watering time. If the station has been included in another program, “USED” appears in the display.

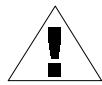

NOTE: If “USED” appears, you can still set a watering time for the station *unless* the station has been previously assigned to the D-drip program. Stations assigned to the D-drip program cannot be used by any other program.

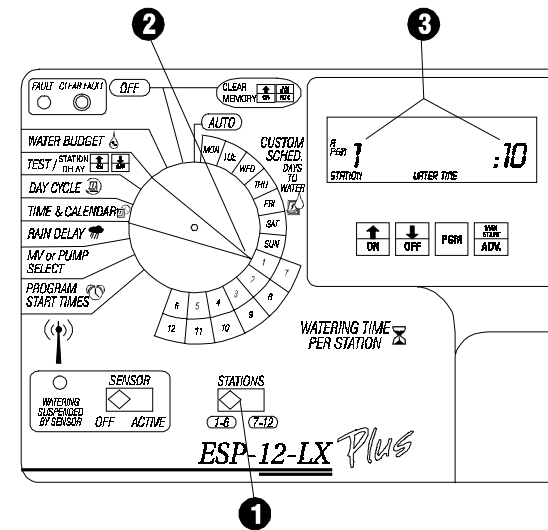

- 4 If the program you want is not displayed, press “PGM” until it appears.
- 5 Press \uparrow or \downarrow to set the length of time you want the station to run. Repeat steps 2 - 5 for all stations. If you do not want to include a station in the program, set the run time to zero.
- 6 After you have set the run time for the last station, turn the dial to “AUTO.”

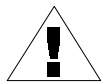

NOTE: You can use the Water Budgeting feature to set watering times of less than one minute. For example, if you set a station watering time of one minute and adjust Water Budgeting to 50 percent, the station will run for 30 seconds. See page 23 for instructions on setting the Water Budget.

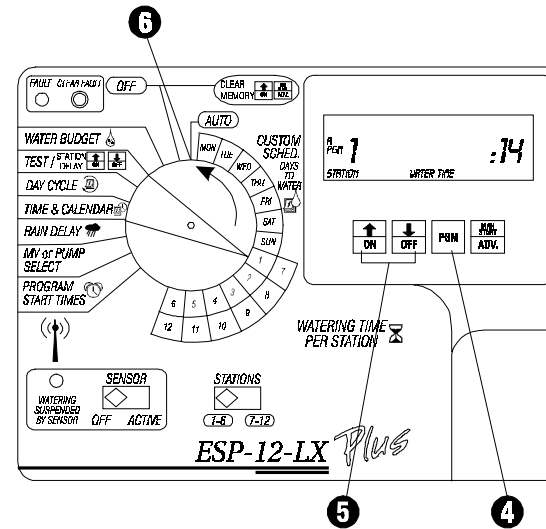

Set Program Start Times

You may assign up to six start times to *each* program per day. A program may start on any quarter hour. Multiple start times let you run a program more than once on each watering day.

For example if you are growing new lawn seed, you may want to water several times a day to keep the seedbed or top dressing damp.

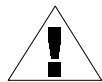

NOTE: Start times apply to the entire **program**, not to an individual station.

- 1 Turn the dial to “PROGRAM START TIMES.”
- 2 The display shows the program, the number of the start time, and the start time itself. The start time number flashes.
- 3 If the program you want is not displayed, press “PGM” until it appears.
- 4 Press \uparrow or \downarrow to select one of the six start time numbers for the program.
- 5 Press “MAN. START/ADV.”
- 6 The program start time flashes.

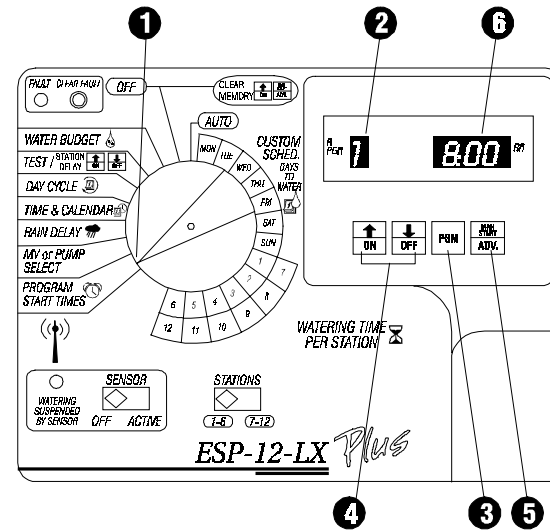

- 7 Press \uparrow or \downarrow to set the start time. Start times are available in 15-minute intervals throughout the day.

To eliminate a start time, leave the dial on “PROGRAM START TIMES.” Choose the start time to be deleted and push “MAN. START / ADVANCE” until the time flashes. Then press the \uparrow or \downarrow buttons until the LCD displays the “OFF” setting, located between 11:45 p.m. and 12:00 a.m. (between 23:45 and 24:00 for International models).

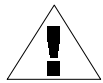

NOTE: Start times appear in chronological order. If you delete a start time by setting it to “OFF,” all later start times are automatically moved down one start time number.

When you set a start time for any start time number, the controller automatically reorganizes the start times so they appear in chronological order. The earliest start time will be number 1, and the latest start time will be number 6. This reorganizing only occurs after you move the dial off the “PROGRAM START TIMES” position.

- 8 If you want to set additional start times, press “MAN. START/ ADV.” Repeat steps 2 - 7 to set the next start time.
- 9 Turn the dial to “AUTO.”

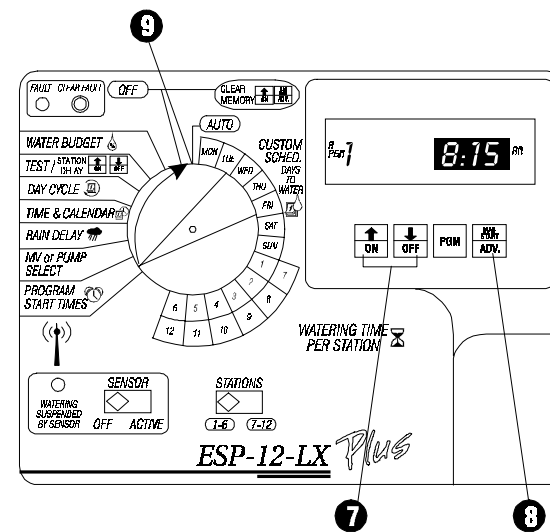

Set Water Budget

The water budget feature lets you increase or decrease the run times of all stations on each program by a selected percentage. You can set the percentage from 0 to 300, in increments of one percentage point. Each program (A, B, C, and D) can have a different water budget percentage.

You can use the water budget feature to cut back watering during cool winter months, or to increase watering during periods of unusual heat.

In addition, you can use the 0% setting to shut off a program temporarily.

Water budget percentages are calculated based on the normal programmed run times for each station. For example, if a station is programmed to run for 10 minutes, and you set the water budget to 80%, the station will run for 8 minutes (80% of 10). If you set the water budget to 120%, that same station will run for 12 minutes (120% of 10).

- 1 Turn the dial to “WATER BUDGET.”
- 2 The display shows the selected program and its current water budget percentage. The default is 100%.
- 3 If the program you want is not displayed, press “PGM” until it appears.
- 4 Press \uparrow or \downarrow to set the percentage.
- 5 To set water budgeting for another program, press “PGM” until the program appears. Then repeat step 4.
- 6 Turn the dial to “AUTO.” When the water budget for a program is set higher or lower than 100%, “WATER BUDGET” appears in the display whenever the program is selected.

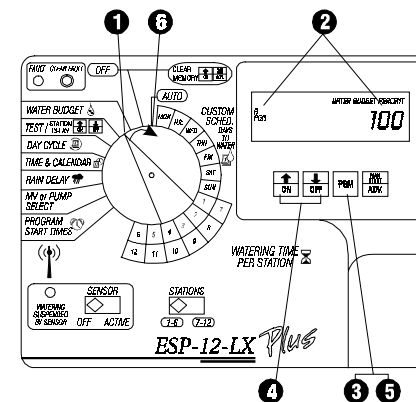

Set Station Delays

The station delay feature lets you program a pause between the end of one station's watering operation and the beginning of the next station's operation. You may set a delay from one second to nine hours.

You can use station delays to let a water well recover or to allow slow-closing valves to turn off completely. If neither of these situations applies to your site, leave the station delay set to 0.

You can set a different station delay for each program. A station delay applies to **all** stations on a given program.

Because the station delay feature is not used very often, it has been “hidden” behind the “TEST / STATION DELAY” position on the dial.

- 1 Turn the dial to “TEST / STATION DELAY.”
- 2 The display shows “TEST” and the standard two-minute run time for the test program.
- 3 Press **↑ AND ↓** at the same time.

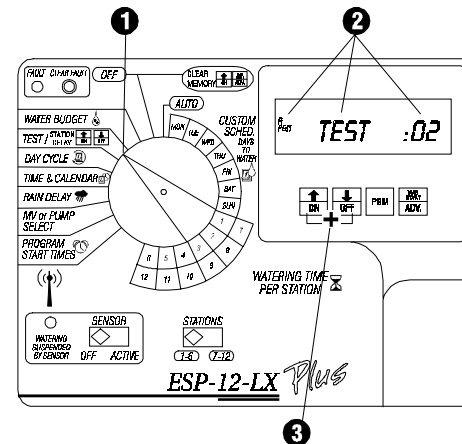

- 4 “DELAY” appears in the display momentarily, followed by the delay time.
- 5 If the program you want is not displayed, press “PGM” until it appears.
- 6 Press \uparrow or \downarrow to set the delay time. To cancel station delay, set the delay time to zero.

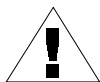

NOTE: The display initially shows the delay time in seconds (“SEC”). When you advance past 59 seconds, the display changes to “MIN” for minutes and seconds. When you advance past 60 minutes, the display changes to “HOUR” for hours and minutes.

- 7 To set delays for additional programs, press “PGM” until the program you want appears. Repeat step 6.
- 8 Turn the dial to “AUTO.”

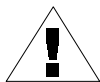

NOTE: During the delay between stations, the master valve / pump relay is not active. See page 26 for instructions on setting the master valve / pump relay.

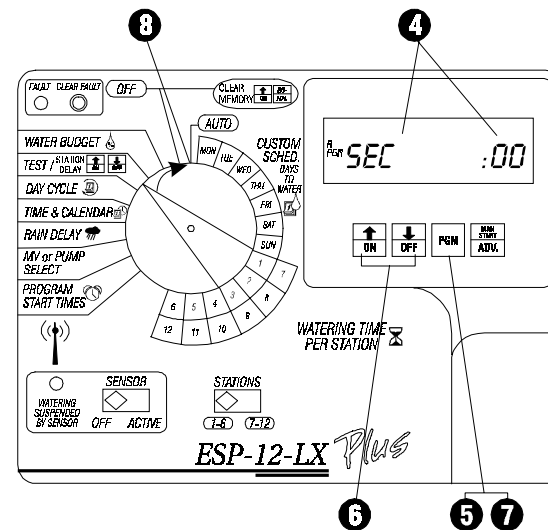

Set MV / Pump Starts

You can assign a master valve relay or a pump start relay to each station. This means that any time the station operates, the relay assigned to it will also turn on. For example, if a specific station needs additional water pressure, you may want to activate a booster pump whenever that station turns on.

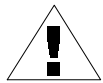

NOTE: Stations that have a master valve / pump relay assigned to them must be wired properly to activate the relay. See pages 53-55 for instructions.



CAUTION: If an unused station is turned on and activates a pump start relay, the pump may overheat or cause a pipe to burst. To prevent operating a pump with no flow (*deadheading*), make sure all unused stations have a zero run time.

- 1 Turn the dial to “MV or PUMP SELECT.”
- 2 The display shows the station number and “MV ON” or “MV OFF.” The station number flashes.
- 3 Press \uparrow or \downarrow to select the station number you want to set.
- 4 Press “MAN. START/ADV.”

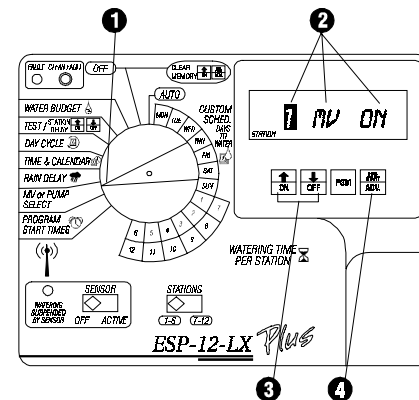

- 5 The "ON" or "OFF" flashes in the display.
- 6 Press \uparrow for ON or \downarrow for OFF.
- 7 To set another station, press "MAN. START/ADV." Repeat steps 2 - 6 for each station you want to set.
- 8 Turn the dial to "AUTO."

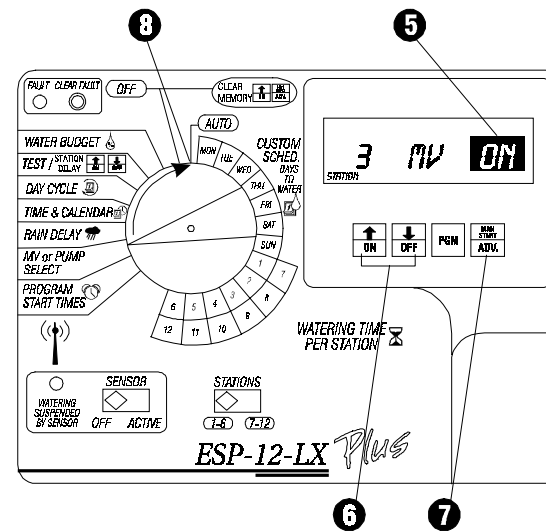

Set Rain Delay

ESP-LX+ and -LXi+ controllers let you manually delay watering for up to 14 days. For example, if rainy weather lasts for 2 or 3 days, you can set a Rain Delay of 5 or 6 days to let the landscape dry out before resuming normal watering.

The Rain Delay setting applies to all programs. You can run programs manually during the Rain Delay period.



NOTE: The Rain Delay feature lets you set a delay period *manually*. If you have an automatic rain sensor attached to your system, see the instructions on page 31.

- 1 Turn the dial to “RAIN DELAY.”
- 2 The display shows “RAIN DELAY” and the number of days remaining until the next watering day. If there is no Rain Delay set, zero will appear in the display above the words “DAYS REMAINING.”
- 3 Press \uparrow or \downarrow to set the number of days to wait until the next watering day. To cancel a Rain Delay, set the number of days to zero.
- 4 Turn the dial to “AUTO.”

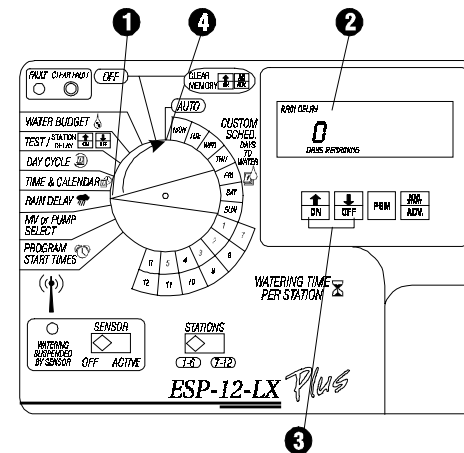

Set Calendar Days OFF

The Calendar Day OFF feature lets you:

- Temporarily suspend watering on a specific day of the month (selected up to 30 days in advance). For example, if you are planning a picnic on July 4th, you can set July 4th OFF, so no watering will occur. After July 4th passes, the fourth of each month will be automatically reset to ON.

- Permanently set the 31st day of any month OFF. This setting complies with local watering ordinances that prohibit watering on the 31st. Unlike settings for other days of the month, this setting remains in effect until you change it.

A Calendar Day OFF setting applies to all programs.

- 1 Turn the dial to “TIME & CALENDAR.”
- 2 Press “MAN. START/ADV” **five** times.
- 3 The display shows the day of the month and its ON or OFF setting. The day of the month flashes.
- 4 Press \uparrow or \downarrow to select the day of the month you want to set.

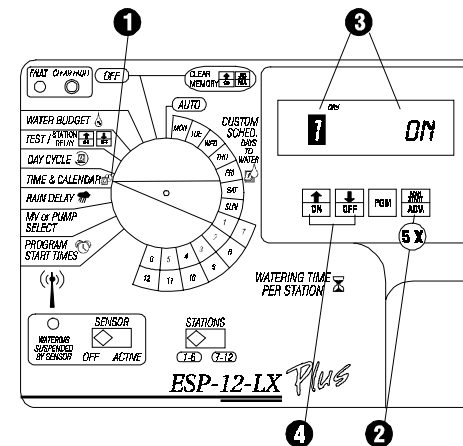

- 5 Press “MAN. START/ADV.”
- 6 The ON or OFF setting flashes.
- 7 Press \uparrow to set the day ON or \downarrow to set the day OFF.
- 8 Turn the dial to “AUTO.” When an OFF day occurs, the display shows “NON” (for non-watering day), and no watering occurs. The next time the date occurs, normal watering schedules will resume (except for the 31st of the month, which remains OFF until you reset it manually).

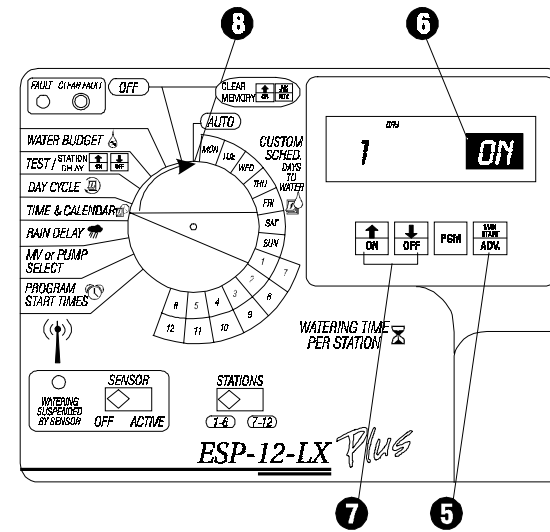

Set Sensor System and Bypass Switch

ESP-LX+ and -LXi+ controllers let you connect a sensor system that interrupts watering when a “wet” condition is detected. For example, if you have a Rain Bird Rain Check™ sensor connected to the controller, irrigation will be prevented when rainfall reaches the shutoff level in the sensor’s collector cup.

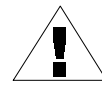

NOTE: For this feature to operate properly, the sensor must be connected according to the instructions on page 54.

- To activate the sensor system, set the sensor bypass switch to “ACTIVE.” The controller will operate normally until a wet condition is detected by the sensor.

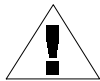

NOTE: If no sensor is attached to the controller, make sure the supplied jumper connects the two SENSOR terminals on the controller’s circuit board. If you set the sensor bypass switch to “ACTIVE” without a sensor or jumper connected to these terminals, the valves will not operate, and no watering will occur. See page 54 for instructions.

- When the sensor detects a wet condition, power to the valves will be interrupted, and no watering will occur (including manual program or station operation.) The “WATERING SUSPENDED BY SENSOR” indicator will light up.

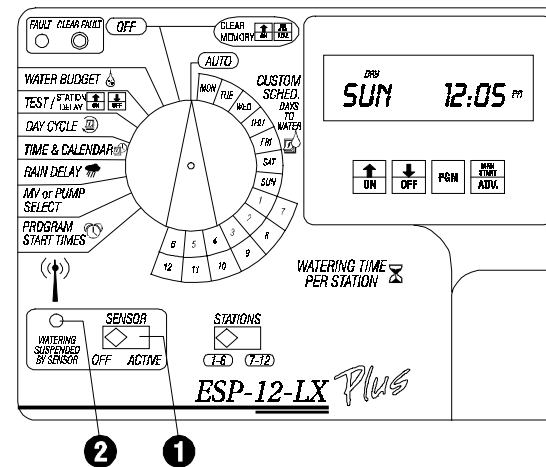

- ③ To bypass the sensor, set the sensor bypass switch to “OFF.” The controller will ignore any sensor signals, and normal watering schedules will resume. This setting also lets you run programs and stations manually.

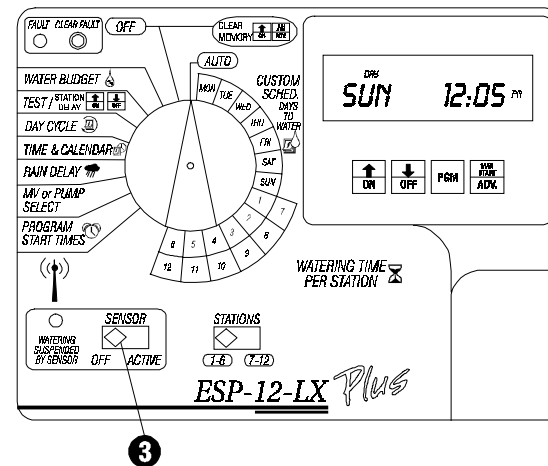

OPERATING THE CONTROLLER

After you have programmed the controller, you will normally set it to operate automatically.

You can also manually run one or more programs, and you can manually operate a single station or several stations.

In addition, you can run a test program to test the operation of all stations on the system. To operate automatically, run programs or stations manually, or run a test program, the controller should be connected to a 120 volt AC power source (230 volt AC for international models).

Operate Controller Automatically

- 1 Turn the dial to “AUTO.” The controller runs the sprinklers according to the programs you have set.

If you forget to turn the dial to “AUTO,” the controller will eventually set itself to automatic operation. The only setting that prevents automatic operation is OFF (see step 2).

- 2 To turn off the controller and prevent all watering, turn the program dial to “OFF.” The display will show the current day and time, and the right-hand minute digit will flash, indicating that the controller has been turned off.

You can use the “OFF” setting to suspend watering during rainy periods, seasonal shutdown, or system maintenance.

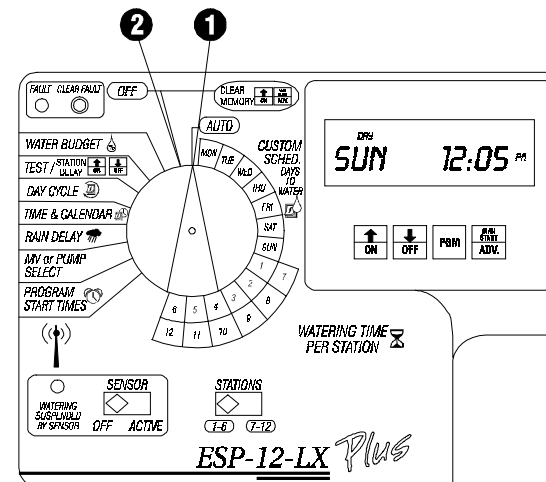

Run Program(s) Manually

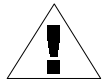

NOTE: To run a program manually, please follow the instructions below carefully. Unlike other ESP controllers, ESP-LX+ and -LXi+ controllers have completely independent programs. Therefore, you must select a program **before** you press the “MAN. START / ADV.” button.

- ❶ Turn the dial to “AUTO.”
- ❷ The display shows the day of the week and time of day.
- ❸ Press “PGM” until the program you want is displayed.
- ❹ Press “MAN. START / ADV.” to start the selected program.

If you want to run additional programs, repeat steps 3 and 4. Each program you select will run when the previous program has ended. You can “stack” all four programs to run in sequence.

- ❺ To cancel all programs currently selected to run, turn the dial to “OFF” for three seconds. Then turn the dial back to “AUTO.”

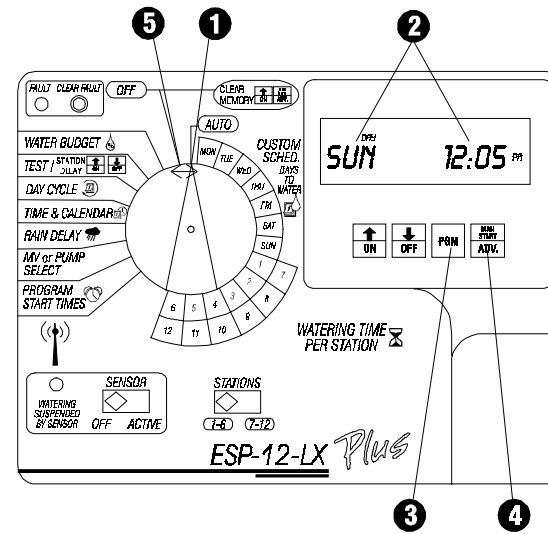

Run Station(s) Manually

- 1 On 12-, 16-, 20-, and 24-station models, set the “STATIONS” slide switch to the block of stations containing the one you want to run.
- 2 Turn the dial to the station number you want in the “WATERING TIME PER STATION” section of the dial.
- 3 The display shows the currently selected program, the station number, and the station’s run time. If the station is not used in the current program but is used in another program, the word “USED” will appear in the display instead of the run time.
- 4 Press “PGM” until the display shows a run time for the station.
- 5 Press “MAN. START / ADV.” to operate the selected station. If you want to run additional stations, repeat steps 3 to 5. Each station you select will run when the previous station has ended.
- 6 After selecting all the stations you want to run, turn the dial to “AUTO.” The stations you have selected will operate for their programmed run times and then shut off automatically.
- 7 To cancel the manual operation of all selected stations, turn the dial to “OFF” for three seconds. Then turn the dial back to “AUTO.”

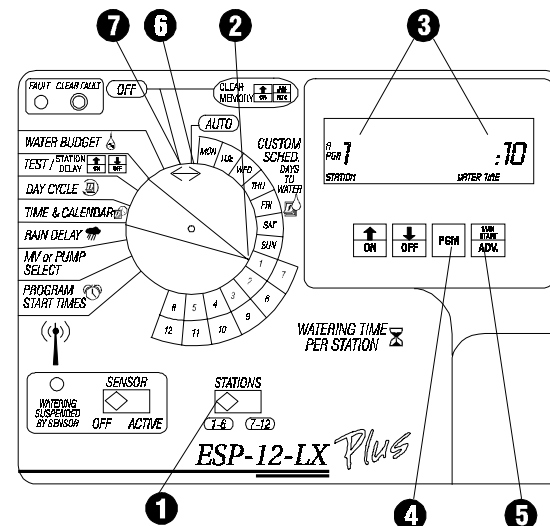

Run Test Program

The controller's built-in test program will run each station that has a non-zero watering time assigned to it. When you run the test program, the controller will operate each station in numerical sequence, from lowest to highest. You can use this program to check the operation of all the sprinklers in the system.

- 1 Turn the dial to "TEST/ Station Delay."
- 2 The display shows "TEST" and the amount of time each station will run. The default test run time is two minutes per station.
- 3 Press \uparrow or \downarrow to increase or decrease the run times for the TEST PROGRAM. The maximum test run time is 10 minutes.
- 4 Press "MAN. START/ADV." to start the test program.
- 5 Turn the dial to "AUTO."
- 6 The display shows the number of the station that is running, along with its remaining run time. The controller runs each station in sequence, from lowest number to highest. The test program skips any stations that have zero watering times assigned to them. When the test program is finished, the controller returns to automatic operation.
- 7 To cancel a test program after it has started, turn the dial to "OFF" for three seconds. Then turn the dial back to "AUTO."

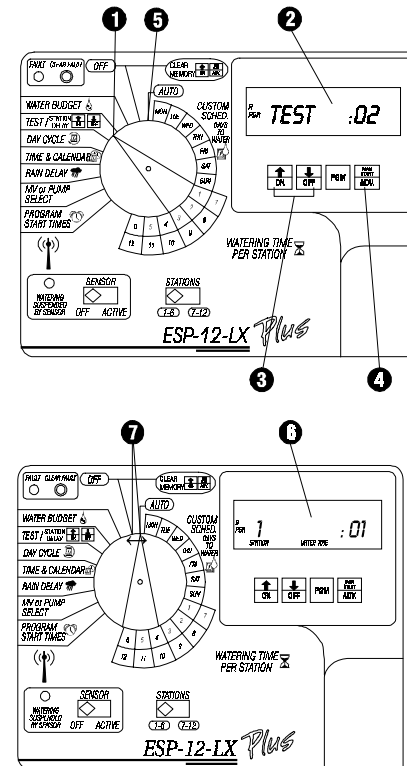

ESP-LX+ & LXi+ Installation, Programming, & Operation Guide

RAPID STATION TEST ROUTINE — RASTER™

Introduction

Rain Bird's **RA**pid **ST**ation **TE**st **R**outine (RASTER) lets you diagnose and troubleshoot field wiring, solenoid, and controller problems quickly and easily.

The RASTER sends an electric signal to each valve terminal on the controller and then displays the valve's current operating condition. Results appear in the easy-to-read digital display.

The RASTER checks each station and displays one of three results:

1. **OPEN** The circuit between the controller and the valve is open; i.e., no current is flowing.
2. **SHORT** The circuit between the controller and the valve has a short; i.e., current is flowing on an unintended path.
3. **FAIL** The controller was unable to send the test signal to the stations. This indicates a possible problem with the controller's internal circuitry.

The RASTER is available on indoor and outdoor versions of Rain Bird's ESP-LX+ and -LXi+ controllers.

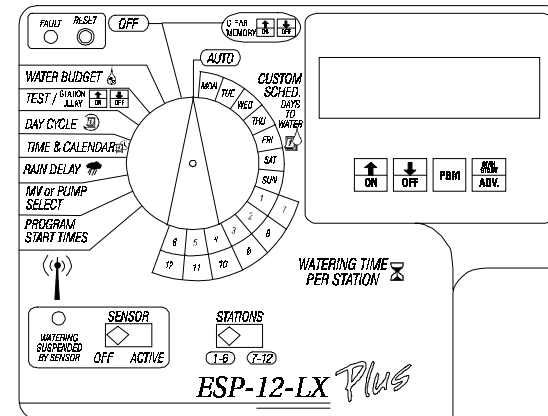

RASTER Operation

Running a RASTER (Rapid Station Test Routine)

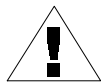

NOTE: To run the RASTER, the controller must be connected to a 120 Volt AC power source (230 Volt for international models).

- 1 Turn the Programming Dial to “OFF.”
- 2 Press and release the “ON” and “OFF” buttons at the same time.
- 3 The display will look like this.

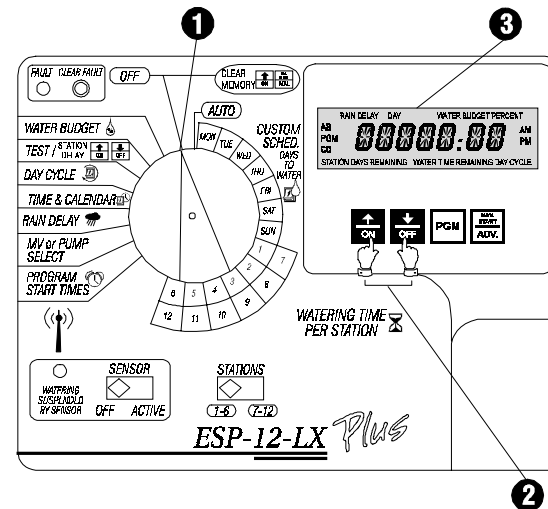

- 4 Press the “MAN START/ADV” button to begin the RASTER.
- 5 The display shows “TEST IO,” and the FAULT Indicator light flashes once as the RASTER confirms the proper operation of the controller’s front panel lights.

The RASTER then automatically checks the controller’s master valve and each station valve (in numerical order).

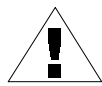

NOTE: If the front panel ribbon cable is not connected to the circuit board or the controller is disconnected from the main power supply, the LCD will display the message “NO OUT.”

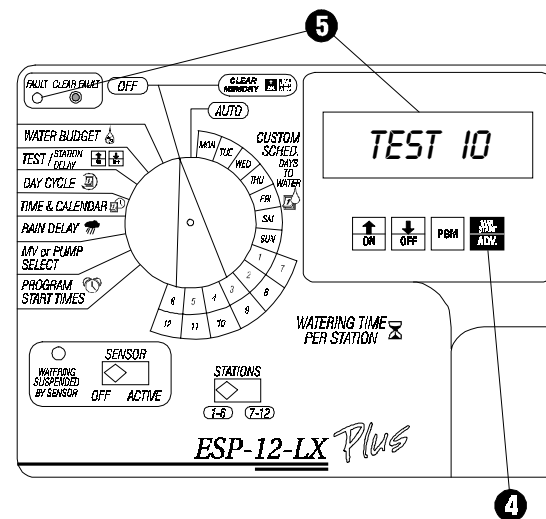

Valve Testing

- ❶ The display briefly shows “TEST” (may flash too rapidly to be seen) and the station number (or “MV” for “master valve”) being tested.
- ❷ The display shows the valve’s operating condition (“PASS,” “FAIL,” “OPEN,” or “SHORT”), followed by the station number (up to 24 stations, depending on controller model). This sample display indicates a short on valve station number 4.
- ❸ The RASTER displays the condition of each valve for 10 seconds, (“PASS” displays for less than one second and may flash too fast to be seen) and then moves to the next valve. You can press “MAN START/ADV” (or any other magenta button) at any time to advance to the next station to be tested.

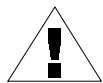

NOTE: Any controller station that does not have a valve connected to it will appear as “OPEN.” This is normal and does not indicate any problem with the controller or system valves.

For example, if you have a 12-station controller with only stations 1 through 10 connected to valves, stations 11 and 12 will show “OPEN” on the RASTER.

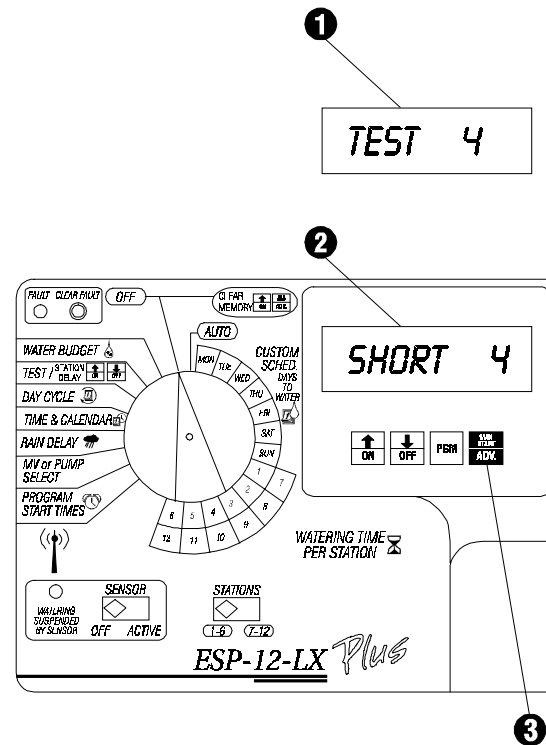

- 4 If the master valve and all station valves pass the RASTER, the display flashes "PASS" for 10 seconds. The controller then returns to normal operation (i.e., waiting for its next start time).

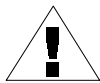

NOTE: If any unconnected valve station caused the RASTER to display an OPEN message, (see NOTE on previous page), the PASS message will not be displayed. This is normal and does not indicate any problem with the controller or the valves.

- 5 If the RASTER detects a problem on the master valve or any station valve, the display flashes "CHECK" for three seconds.
- 6 The display shows the condition and number of each problem station. Each problem station will flash in the display for five seconds. Press "MAN START/ADV" at any time to display the next problem station.
- 7 If any station displays "FAIL," it means the controller was unable to send the test signal to the valve, indicating a possible problem with the controller's internal circuitry. Call Rain Bird Technical Assistance at 800-247-3782, or contact your local authorized Rain Bird distributor to service your controller.

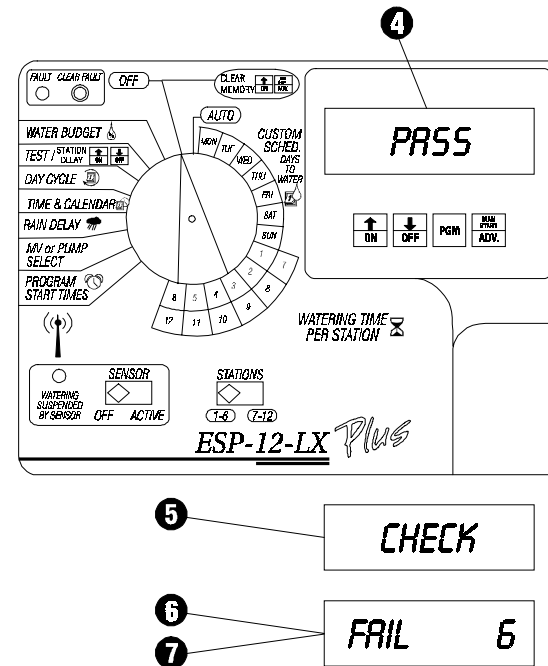

- ⑧ Any valve displaying “OPEN” or “SHORT” should be checked for field wiring or other circuit problems. See “Troubleshooting Open and Shorted Valves Circuits” on page 43 for more information.
- ⑨ To exit the RASTER, turn the Programming Dial from “OFF” to “AUTO” (or any other dial position).
- ⑩ The controller returns to normal operation, awaiting its next scheduled start time.

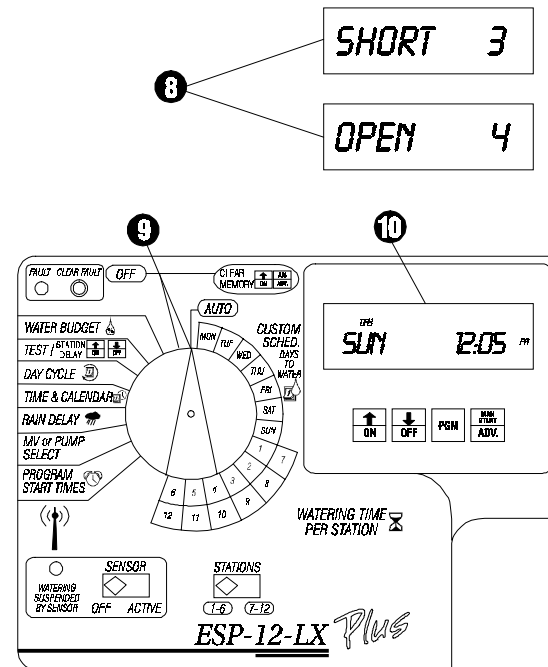

Troubleshooting Open and Shorted Valve Circuits

Open Circuits

An “OPEN” condition reported by the RASTER indicates a complete break in the current flow between the controller and the valve.

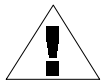

NOTE: The RASTER will display an “OPEN” condition if no valve solenoid is connected to the controller station. This is normal, and the system does not need service.

Open circuits can be caused by:

- Malfunctioning valve solenoids
- Field wires that have been cut or pulled loose
- Loose wire connections on the controller’s terminal strip or at the valve solenoid
- Damaged components on the controller’s internal circuit board



Short Circuits

A “SHORT” condition reported by the RASTER indicates an unintended re-routing of current flow somewhere between the controller and the valve.

Short circuits can be caused by:

- Shorted valve solenoids
- Nicked or “skinned” field wires
- Loose or corroded wire connections on the controller’s terminal strip or at the valve solenoid
- Malfunctioning components on the controller’s internal circuit board

Troubleshooting Opens and Shorts

To troubleshoot a valve station identified as “OPEN” or “SHORT:”

- ❶ Make sure the valve’s station wires are securely connected to the controller’s terminal strip.
- ❷ If the wires are securely connected, move the station’s wires to a station that passed the RASTER. Then re-start the test.
- ❸ If the “OPEN” or “SHORT” recurs on the original station, the controller’s internal circuitry may need service.
- ❹ If the “OPEN” or “SHORT” moves to the new station, check the valve’s solenoid and field wiring.

INSTALLING THE CONTROLLER

This section of the manual explains how to mount the controller on the wall and connect the wiring.

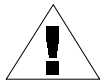

NOTE: This controller must be installed in compliance with local electrical codes.

The ESP-LXi+ controller must be installed indoors only. The “i” in the model number stands for “indoors.”

The ESP-LX+ controller may be installed either indoors or outdoors.

Installation Checklist

To install the ESP-LX+ controller, we recommend that you complete the following steps in order. For your convenience, a check-off box () is provided for each step.

- Select location. Page 46
- Remove door and face panel. Page 48
- Mount controller on wall. Page 50
- Connect field wires. Page 52
- Connect sensor system (optional). Page 54
- Connect main power wires. Page 56
- Install battery. Page 62

Select Location

Follow these guidelines to select a location for the controller:

- ❶ Select an area protected from vandalism, where the user can easily reach the controller. We recommend mounting the controller at eye level in a utility room.

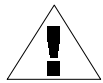

NOTE: To minimize electromagnetic interference, select a location at least 15 feet (4,6 m) away from high-draw motors such as air conditioners, refrigerators, or pool pumps.

- ❷ Select a location that has access to 120-Volt AC electrical power or 230-Volt AC electrical power (as required).



WARNING: A circuit breaker or cutoff switch is to be provided in the fixed wiring to isolate the controller.

- ❸ Choose a flat, stable, vertical surface. Allow enough clearance for electrical conduit and connections at the bottom of the plastic cabinet.
- ❹ Allow at least 9½" (24,2 cm) of horizontal clearance so the hinged cabinet door can swing fully open to the left.

- ❺ Allow at least 6¾" (17,2 cm) of clearance above the cabinet door so the hinge pin can be removed to service the controller.

Remove Door and Face Panel

Before you mount the controller, we recommend that you remove the door and face panel. Although these steps are not absolutely necessary, they will make installation more convenient.

- ❶ Open the door and swing it to the left. If necessary, unlock the door with the supplied key.
- ❷ Flip the upper tip of the hinge pin out of the groove in the door so it is pointing at you.
- ❸ Support the door and slide the hinge pin upward until it clears the hinges. Then remove the door.
- ❹ Open the face panel by grasping its lower right corner and swinging it to the left.
- ❺ Disconnect the ribbon cable by grasping it along its two flat sides. Then pull the cable gently out of its connector.
- ❻ Unplug the two-wire harness by releasing the latch on the side of the connector. Then pull the connector away from the terminal board.

- ❼ Press down on the upper flexible hinge to release the hinge knob from its hole in the cabinet.
- ❽ Pull the lower hinge knob out of its hole and remove the panel.

To reconnect the face panel and door, repeat the steps above in reverse order. Make sure to reconnect the ribbon cable and two-wire harness to their connectors for proper controller operation.

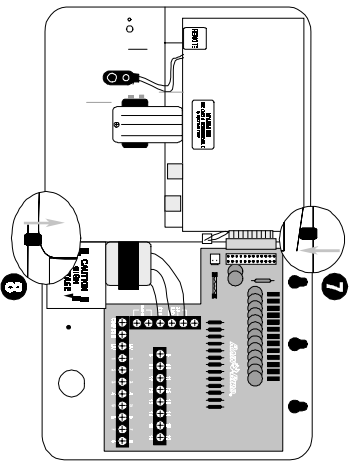
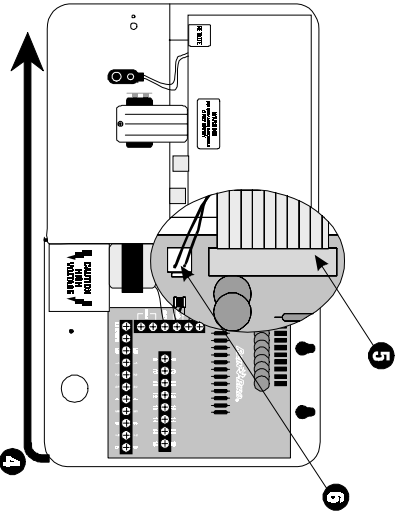
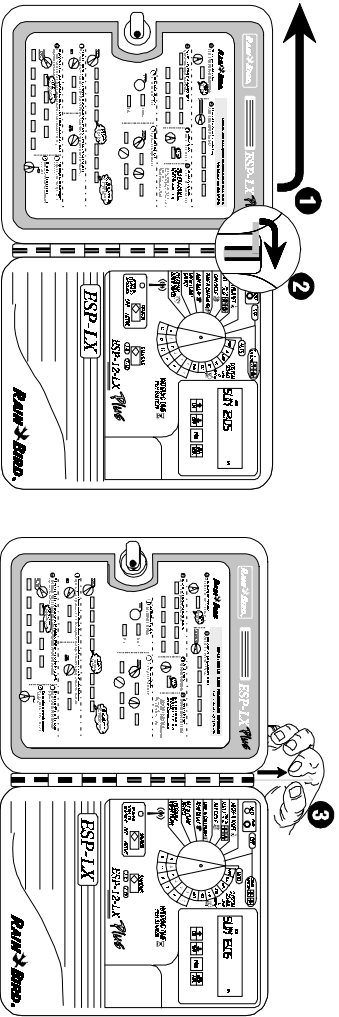

Mount Controller on Wall

The ESP-LX+ has four mounting holes on the back of the cabinet — three “keyhole” slots at the top of the cabinet and one circular hole at the bottom of the cabinet. The shipping carton for the controller contains a mounting template. You may wish to cut this template out and use it to mark the controller’s mounting holes in the desired location before you begin drilling.

- ❶ To install the controller on a flat wall surface, use the left and right keyhole slots at the top of the cabinet.
- ❷ To install the controller on a narrow stud, use the center keyhole slot.
- ❸ For all installations, use the small round hole at the bottom of the cabinet.
- ❹ Hold the controller or mounting template at eye level against the mounting surface. Use a pencil to mark the position of the holes on the mounting surface. Then remove the controller cabinet or template.
- ❺ On flat wall surfaces, drive an appropriate fastener for the type of wall into the two outside keyhole marks.
- ❻ For narrow stud installations, drive an appropriate fastener for the type of wall into the middle keyhole mark.
- ❼ Use a nail to tap a small pilot hole on the mark for the lower mounting hole. However, DO NOT drive a fastener into this location yet.
- ❽ Use the keyhole slot(s) to hang the controller cabinet on the fasteners. Make sure the shafts of the fasteners are well up in the narrow part of the keyholes.
- ❾ Drive the last fastener through the lower mounting hole. Verify that the cabinet is secure. If necessary, tighten the fasteners in the upper keyhole slot(s).

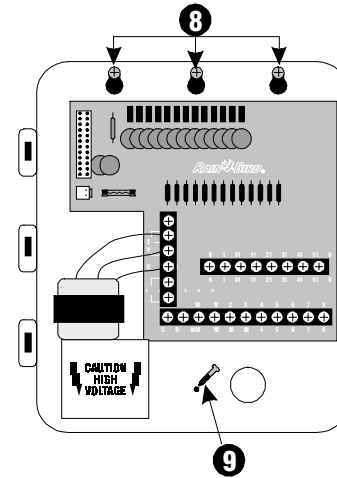
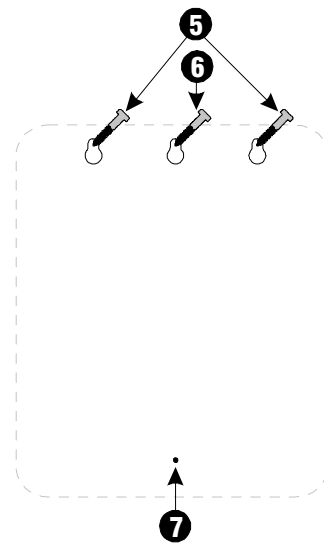
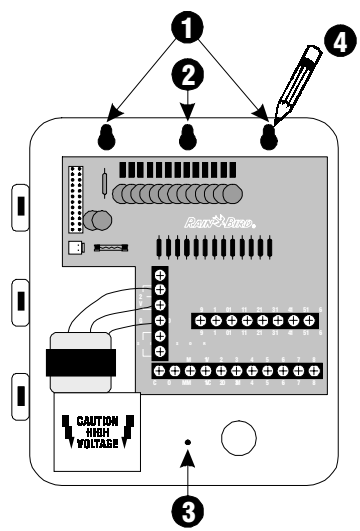

Connect Field Wires

Field Wire Entrances

The ESP-LX+ cabinet has four knockouts for routing field wires from the valves. Two are located on the underside of the cabinet, and two are located on the back of the cabinet.

- ❶ The underside of the cabinet has a hole sized for a 1" (2,6 cm) PVC male adapter so you can easily install a 1" (2,6 cm) PVC pipe or conduit for the valve wires.
- ❷ A larger knockout for a 1¼" (3,2 cm) PVC male adapter is molded into the underside of the cabinet, surrounding the hole for the 1" (2,6 cm) PVC adapter. You may need this larger hole if you are using #14 gauge wire or larger.

To use the larger hole, turn the cabinet upside down. Place the blade of a slot-head screwdriver in the groove around the knockout. Then firmly tap the handle of the screwdriver to punch in the knockout. You may need to punch the groove in two places.

- ❸ If you wish to route the field wires through the wall on which the controller is mounted, use the knockout for the 1" (2,6 cm) PVC adapter on the back of the controller cabinet. Use a screwdriver to punch out the knockout, as described in step 2.

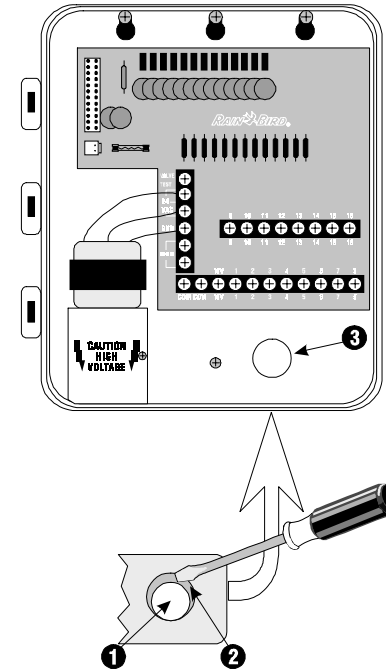

Station Valve Wiring

Connect each valve by its own separate power wire to one of the numbered terminals on the ESP-LX+ terminal strip, as shown in the illustration. You may connect up to two 24 VAC, 7VA solenoid valves per station. You may use the special Valve Test position to help identify valve stations BUT NOT for permanent connections.

To speed up installation, slide the stripped end of the valve wire under the “pinch plate” at each terminal. The pinch plate eliminates the need to wrap the wire around the screw head.

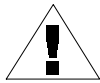

NOTE: The ESP-LX+ 20- and 24-station models have a special screwless terminal strip for valve wire connections.

Connect a common wire to one of the leads on each valve. Connect the other end of the common wire to the COM terminal on the flip strip. Wire used to connect the valves must be code-approved for underground installation.

Master Valve Wiring

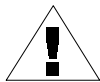

NOTE: Complete this section **only** if your system requires a master valve (an automatic valve installed on the mainline pipe upstream from the station valves) or a pump relay. The controller does NOT provide main power for a pump. Connect the master valve wiring to the MV terminal and COM terminal as shown in the illustration.

ESP-LX+ & LXi+ Installation, Programming, & Operation Guide

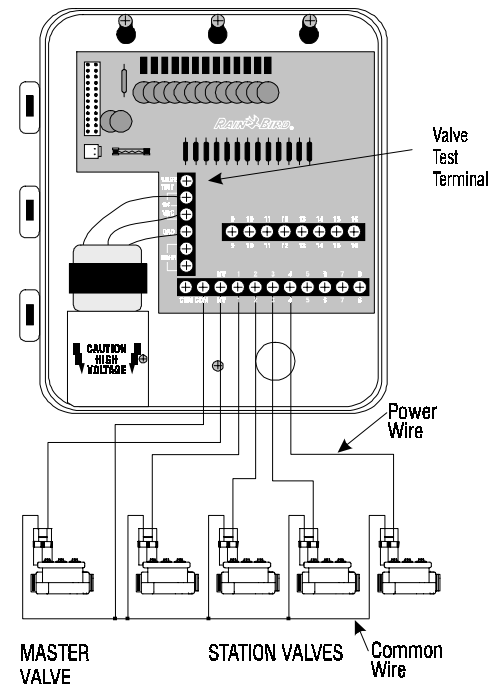

Sensor System Wiring

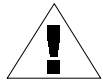

NOTE: Complete this section **only** if your system has an automatic rain sensor.

If you are not connecting a sensor to the controller, make sure the supplied jumper is installed on the two SENSOR terminals on the controller's vertical terminal strip.

- 1 Most sensors have two wires or two terminals designed to be connected to the valve common wire. Instead of connecting to the valve common wire, connect these wires or terminals to the "SENSOR" terminals on the ESP-LX+ or LXi+ controller.
- 2 Route the pair of wires out of the controller cabinet to the sensor system.
- 3 Follow the sensor system's directions for placing and connecting moisture probes, setting the rain shutoff level, and making final adjustments.

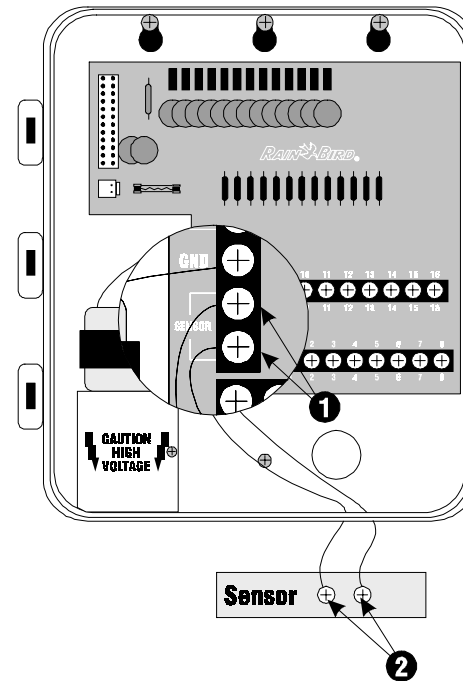

Pump Start Relay Wiring

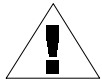

NOTE: Complete this section only if your system requires a pump start relay.

The MV terminal on the controller's terminal strip can be used to connect a pump start relay. Connect one lead of the 24VAC pump start relay to the MV terminal and the other lead to the common wire, as shown in the illustration.

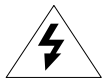

CAUTION: To prevent pump damage when using a pump start relay, use a jumper wire to connect any unused stations to a station that is being used.

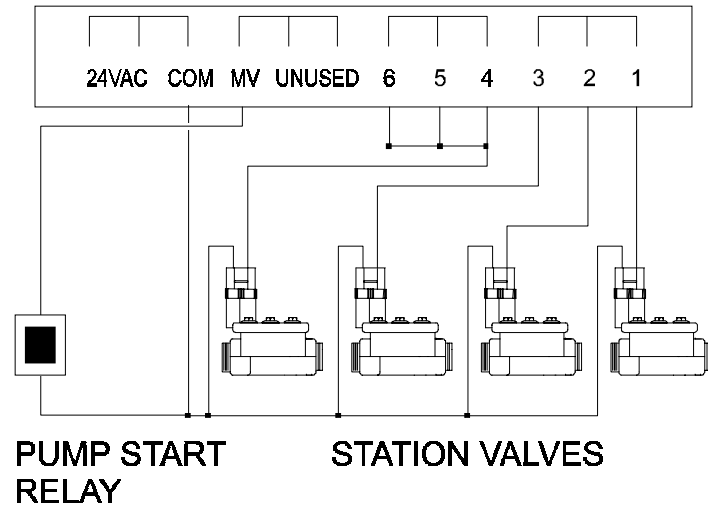

Connect Main Power Wires

ESP-LX+ (Outdoor / Indoor Controller)

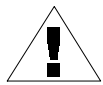

NOTE: To connect main power wires on the ESP-LXi+ indoor-only controller, see the instructions on page 60.

The ESP-LX+ controller has an internal transformer that reduces standard supply voltage (117 VAC in U.S. models; 230 VAC in international models) to 24 VAC to operate the valves connected to the controller. You will need to connect power supply wires to the transformer's three wires.



WARNING: To prevent electrical shock, make sure all supply power is **OFF** before connecting these wires. Electrical shock can cause severe injury or death.

All electrical connections and wiring runs must be made according to local building codes.

- 1 With the door and face panel removed, locate the high-voltage compartment in the lower left corner of the controller cabinet.
- 2 Remove the screw on the right edge of the compartment cover. Then swing the cover open to expose the transformer's primary input wires.

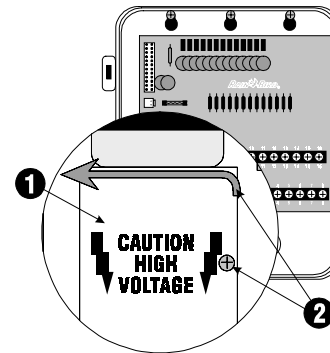

- ③ If you wish to bring the power supply wires through the wall on which you mount the controller, use the 1/2" (1,3 cm) knockout in the rear of the cabinet. Also remove the circular cutout in the flame-retardant fiberboard liner at the rear of the high-voltage compartment. For safety purposes, be sure to seal the unused entry at the bottom of the cabinet.
- ④ If you wish to bring the supply wires through the bottom of the cabinet, attach a 1/2" (1,3 cm) conduit fitting to the bottom entrance of the high-voltage compartment. Then attach conduit to the fitting.

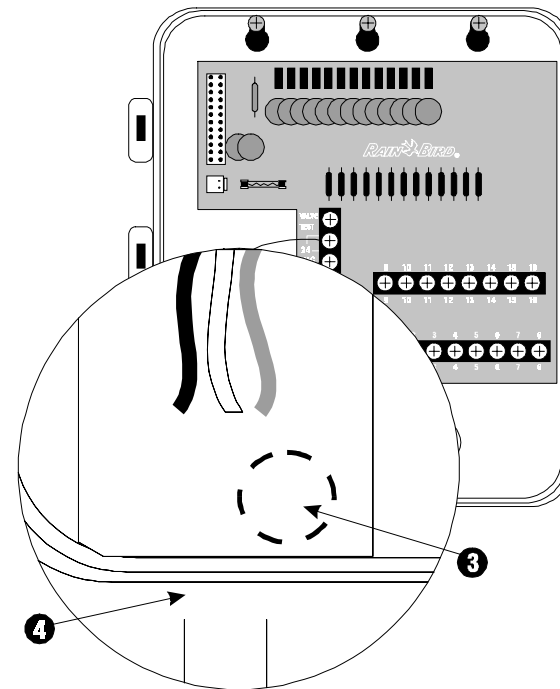

- 5 Bring three supply wires from the power source through the conduit into the high-voltage compartment. Strip the insulation from the incoming wires to expose about ½" (1,3 cm) of bare wire.
- 6 Using a code-approved wire connector, connect the wires as follows:
 - On 117-120 VAC models (U.S.), connect the black supply wire ("hot") to the black transformer wire.
 - On 230 VAC models (international), connect the brown supply wire ("hot") to the brown transformer wire.
- 7 On 117-120 VAC models (U.S.), connect the white supply wire ("neutral") to the white transformer wire.
On 230 VAC models (international), connect the blue supply wire ("neutral") to the blue transformer wire.
- 8 On 117-120 VAC models (U.S.), connect the green supply wire ("ground") to the green transformer wire.
On 230 VAC models (international), connect the green-with-yellow-stripe supply wire ("ground") to the green-with-yellow-stripe transformer wire.

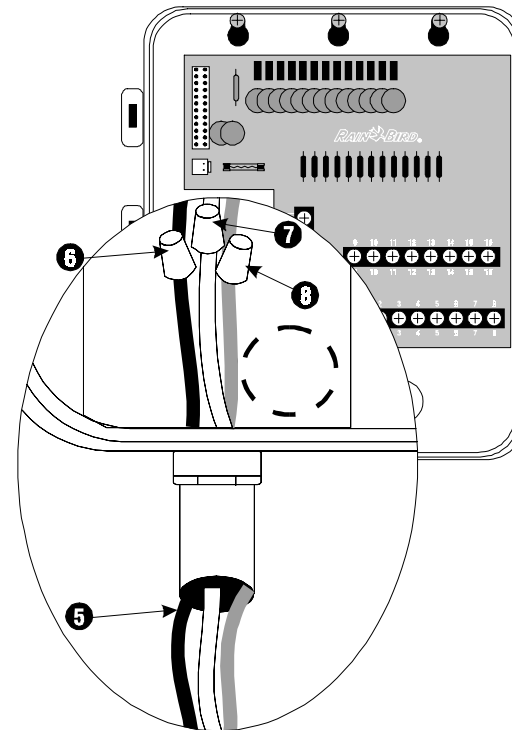

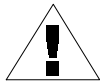

NOTE: The ground wires **MUST** be connected to provide electrical surge protection.

- 9 Verify that all connections are secure. Then close the cover of the high-voltage compartment and secure it with the screw.

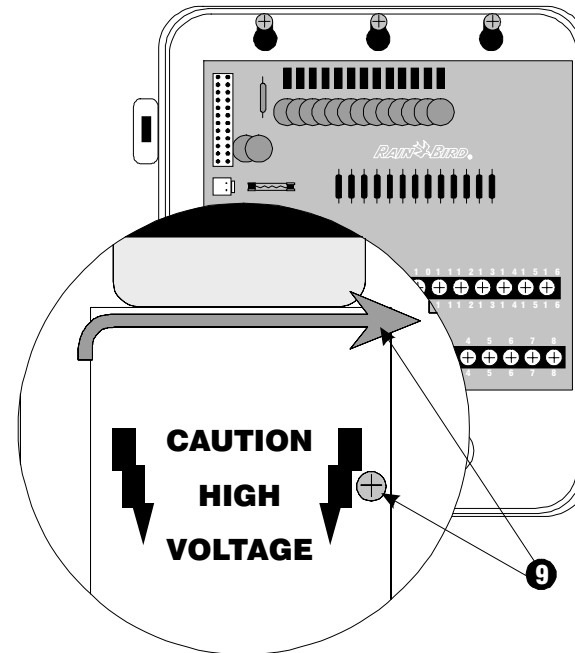

ESP-LXi+ (Indoor-Only Controller)

The ESP-LXi+ controller (117 VAC model only) has an external transformer that reduces standard supply voltage to 24 VAC to operate the valves connected to the controller.

You will need to connect the three wires from the transformer to the vertical terminal strip in the controller cabinet.



CAUTION: To avoid electrical shock, do **NOT** plug in the transformer until you have connected its cable to the controller. If the transformer is plugged in while the cable is not attached, any contact between the three forked connectors will blow the transformer's internal fuse. A blown transformer fuse cannot be repaired.

All electrical connections and wiring runs must be made according to local building codes.

- 1 Make sure the transformer is **NOT** plugged in.
- 2 Feed the three forked transformer wires through the bottom left hole in the cabinet. Then pull about 12 inches of the cable up into the controller cabinet.
- 3 Tie a loose overhand knot in the cable just inside the controller to prevent any strain on the connector terminals.

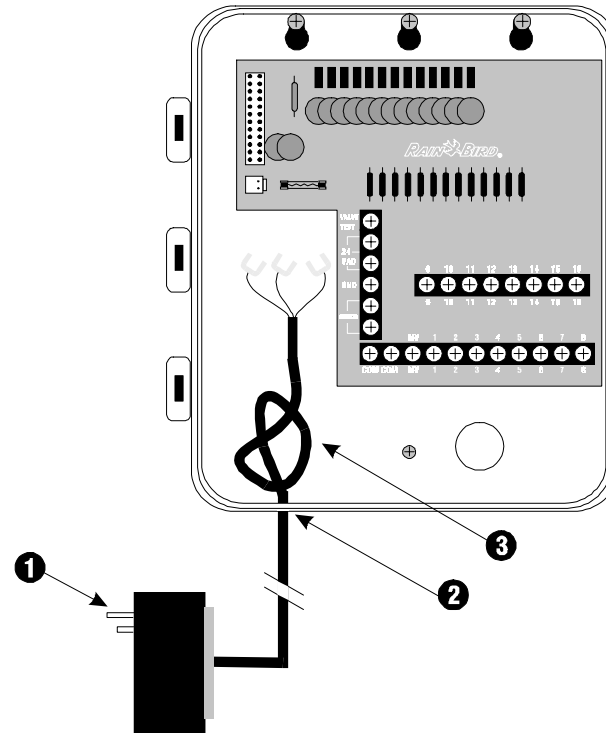

- 4 On the vertical terminal strip, connect the green forked wire to the terminal labeled “GND.”

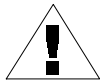

NOTE: The green ground wire **MUST** be connected properly to provide electrical surge protection.

- 5 Snap open the protective cover and connect one of the remaining two forked wires to one of the terminals labeled “24 VAC.” (In some units, these two terminals are labeled “ORN.”) Connect the last forked wire to the other terminal labeled “24 VAC.” Polarity of these two wires is not important. You may connect either wire to either terminal. Then close the protective cover.

- 6 Verify that all connections are secure. Then plug the transformer into any standard three-prong grounded 117 VAC electrical outlet.



CAUTION: To prevent electric shock, match the wide blade of the plug to the wide slot, fully inserted.

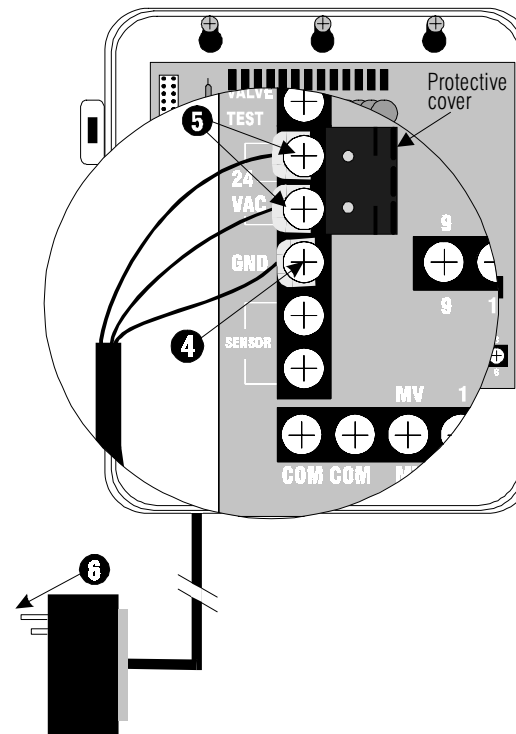

Install Battery

The 9-Volt rechargeable nickel metal hydride (NiMH) battery supplied with the controller provides power to maintain the current time and date during a power outage. All program information you have entered is maintained independently of battery power. So if a prolonged power outage outlasts the life of the battery, you will only have to update the time and date after power is restored (your program is the “default”).



NOTE: Memory of the time and date is retained by a battery which is to be disposed of in accordance with local regulations.

The battery also lets you program the controller with the face panel detached from the cabinet power supply.

- ❶ If you have removed the face panel and cabinet door for a new installation, reinstall them now. Be sure to connect the ribbon cable and two-wire harness from the face panel to the controller’s circuit board, as described on page 48.
- ❷ Loosen the screw on the battery cover, and slide the battery out of its compartment. If you are replacing a used battery, discard the old battery properly. The replacement battery must be a 9-Volt rechargeable NiMH battery.
- ❸ If the battery has a protective cover installed over its terminals, remove the cover. Then connect the two-wire battery clip to the terminals.

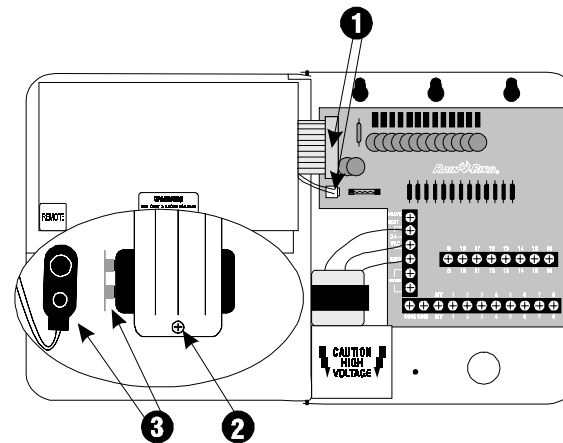

- ④ Slide the battery back into its compartment, and tighten the screw.
- ⑤ The controller will fully charge the supplied NiMH battery in approximately 48 hours. The controller will continue to trickle-charge the battery whenever the controller is supplied with electrical power.

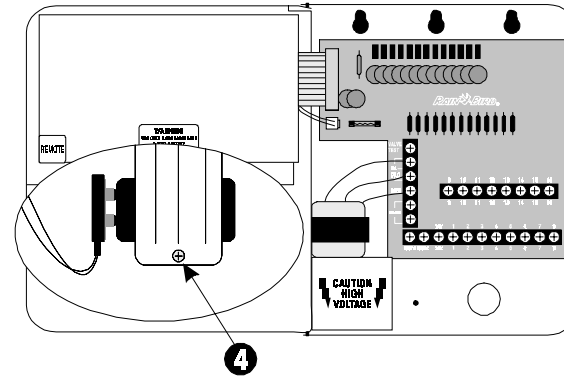

Diagnostic Circuit Breaker

If the ESP-LX+ or ESP-LXi+ controller detects an electrical short circuit on one of the sprinkler system's station wires or valve solenoids, the controller automatically shuts off the station with the fault. After shutting off the shorted station, the controller advances to the next working station in the program.

Every three seconds, the LCD displays the problem station's number and the message "FAULT." The Fault LED will also flash, indicating a station short circuit.

The controller will continue to run each operable station in the program. As each station is running, the controller (at an alternate 3-second interval) displays the working station's number and run time remaining (when the programming dial is set to the AUTO position).

When the controller finishes the program, it will continue to display the problem station's number and the "FAULT" message and the Fault LED will continue to flash.

After the program finishes, you should isolate and repair the short circuit. Short circuits occur most frequently in the valve solenoid (the plastic-encapsulated coil on the valve with the two wire leads), or in the wire connectors to the valve leads.

After you find and repair the short circuit, press the "Clear Fault" button to clear the "FAULT" message from the display and stop the flashing Fault LED. Then you may wish to operate the station manually to make sure it works properly. (See "Run Station(s) Manually" on p. 35).

The LCD display shown below indicates that the controller has detected a short circuit on station 2.

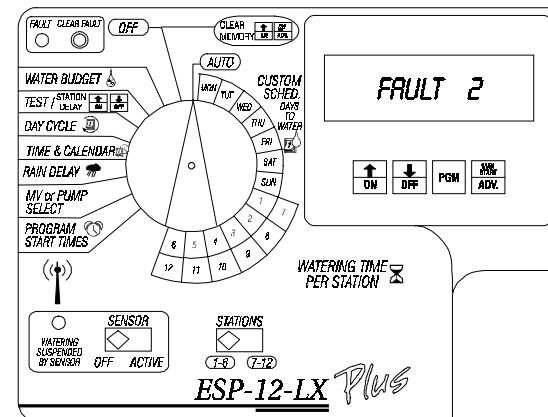

TROUBLESHOOTING

SYMPTOM	POSSIBLE CAUSE	SOLUTION
Program does not come on automatically.	1. Dial is set to OFF position.	Set the dial to AUTO.
	2. Start time has not been entered for the program.	Turn the dial to PROGRAM START TIMES and check the start times entered for the program. If the start time is missing, enter it as described on page 21.
	3. Rain Delay feature is preventing watering. (Display shows "RAIN DELAY" and "DAYS REMAINING.")	If the Rain Delay feature has been set properly, no correction is needed. To cancel the Rain Delay, see page 28.
	4. Today may not be a watering day for the program. (Display shows "DAYS REMAINING" to the next watering day.)	Press the PGM button to check the days remaining until the next watering day for each program.
	5. Day Off feature is preventing watering. (Display shows "NON," followed by the time of day.)	If the Day Off feature has been set properly, no correction is needed. To run a program manually (even on a Day Off), see page 34. To change the Day Off feature, see page 29.
	6. Program's Water Budget is set to 0%.	Set the Water Budget above 0%. See page 23.

SYMPTOM	POSSIBLE CAUSE	SOLUTION
Display shows a station operating, but no watering occurs.	7. Sensor system is preventing irrigation. (WATERING SUSPENDED BY SENSOR light is on.)	Turn the sensor bypass switch to OFF. If watering resumes, the sensor is operating properly, and no correction is necessary.
	8. No sensor or jumper is connected to the controller's SENSOR terminals, and the SENSOR BYPASS switch has been set to ACTIVE.	Turn the sensor bypass switch to OFF. To prevent future occurrences, install the supplied jumper on the controller's SENSOR terminals. See page 54.
Station does not come on.	9. No run time has been set for the station.	Turn the dial to the station number, and press the PGM button to check the run times set for the station. To add a run time, see page 19.
	10. A short circuit in the solenoid or valve wiring has disabled the station. (Display shows "FAULT" and a station number, and the FAULT light in the upper left corner of the face panel is on.)	Identify and repair the fault in the circuit. Then press the Clear Fault button, and start the station manually. See page 35 for instructions.
	11. Sensor system is preventing irrigation. (WATERING SUSPENDED BY SENSOR light is on.)	See correction for Cause #7.
	12. Start time has not been entered for the program to which the station is assigned.	See correction for Cause #2.
	13. Water Budget for the station's program is set to 0%.	See correction for Cause #6.

SYMPTOM	POSSIBLE CAUSE	SOLUTION
Display shows "PWR OFF."	14. No power is being supplied to the controller.	Verify that the controller is plugged into a working outlet. Check the main power supply to the controller.
Display shows "FUSE."	15. Fuse has blown.	Disconnect the controller from its power source. Identify and repair the circuit fault that caused the fuse to blow. Then replace the fuse with the spare fuse supplied on the inside of the face panel, just above the 9-Volt battery. For the ESP-LX+, use a 1.5A SLO-BLO fuse. For the ESP-LXi+, use a 1.25A SLO-BLO fuse. Reconnect power to the controller and reset the time and date.
Display shows "MVFAULT."	16. An electrical fault has occurred in the master valve or pump start relay circuit.	Identify and repair the fault in the master valve or pump start relay circuit. Then press the Clear Fault button in the upper left corner of the face panel. To verify that the problem has been corrected, manually start a program (page 34) or run a test program (page 36).
Display is partially or completely blank.	17. An electrical surge or lightning strike has damaged the controller's electronics.	Turn off the controller and disconnect the 9-Volt battery. Let the controller sit for two or three minutes. Then reconnect the battery and restore power to the controller. Reset the time and date as described beginning on page 11. If the electrical surge did no permanent damage, the controller will accept programming commands and function normally. If the controller does not operate properly, contact Rain Bird Technical Assistance at 800-247-3782 (United States only).

SYMPTOM	POSSIBLE CAUSE	SOLUTION
Watering starts when it should not.	18. MAN START / ADV. key has been pressed.	To cancel a program that has been manually started, set the dial to OFF for three seconds. Then set the dial back to AUTO.
	19. An unwanted start time may have been entered.	Turn the dial to PROGRAM START TIMES and check to see if any programs have an unwanted start time. See page 21 for instructions on setting and eliminating start times.
	20. Programs may be stacked.	Programs A, B, and C will stack behind each other if they are scheduled to start while another program (other than D) is running. Check to make sure Programs A, B, and C are not scheduled to start when any program other than D is scheduled. Refer to page 13.
Display flashes "FAULT #"	21. The controller has detected a short circuit on a particular station. For example, if the display flashes "FAULT 4," it means there is a short somewhere between the controller and station #4.	Identify and repair the shorted circuit. See "Diagnostic Circuit Breaker" on page 64, and "Troubleshooting Open and Shorted Valve Circuits" on page 43 for more information.



NOTES



This equipment has been tested and found to comply with the limits for a Class B digital device, pursuant to Part 15 of the FCC Rules. These limits are designed to provide reasonable protection against harmful interference in a residential installation.

This equipment generates, uses, and can radiate radio frequency energy and, if not installed and used in accordance with the instructions, may cause harmful interference to radio communications. However, there is no guarantee that interference will not occur in a particular installation.

If the equipment does cause harmful interference to radio or television reception, which can be determined by turning the equipment off and on, the user is encouraged to try to correct the interference by the following measures:

- Reorient or relocate the receiving antenna.

- Increase the separation between the equipment and receiver.
- Connect the equipment into an outlet on a circuit different from that to which the receiver is connected.
- Consult the dealer or an experienced radio/TV technician for help.

Changes or modifications not expressly approved by Rain Bird Sales, Inc., could void the user's authority to operate the equipment.

This product was FCC certified under test conditions that included the use of shielded I/O cables and connectors between system components. To be in compliance with FCC regulations, the user must use shielded cables and connectors and install them properly.



RAIN BIRD SALES, INC.

970 W. Sierra Madre, Azusa, California 91702, U.S.A. 626-963-9311

© 2001 Rain Bird Sprinkler Mfg. Corp.

® Registered trademark of Rain Bird Sprinkler Mfg. Corp.

Technical Services for United States only: 800-247-3782

www.rainbird.com